

KHPF 7510

KHPS 7510

Instructions for use



FOR THE WAY IT'S MADE.®

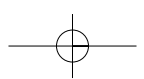
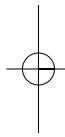
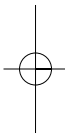

Product description and symbols	4
Using the burners	4
Practical advice on using the hob	5
Positioning the pan supports and wok support	5
Hood and cabinetry clearances (mm)	6
Injector table	6
Warnings and suggestions	7
Safeguarding the environment	8
Installation (Flush and Traditional fitting)	9
Gas connection	9
Electrical connection	10
Fixing the Hob to the supporting structure. Traditionally fitted model (Semi Flush fitting).	10
Fixing the Hob to the worktop. Flush fitted model.	11
Adaption to a different type of gas supply	12
Replacing the injectors	12
Fitting the wok burner	13
Regulating the minimum flow level of the gas taps	13
General cleaning & maintenance	14
Care and maintenance of the gas burners	14
Troubleshooting guide	15
After Sales Service	15

Product description and symbols

1. Removable pan supports
2. 1 kWh auxiliary burner
3. 1.65 kWh semi-fast burner
4. 1.65 kWh semi-fast burner
5. Professional wok burner
6. Auxiliary burner control knob
7. Semi-fast burner control knob
8. Semi-fast burner control knob
9. Professional wok burner control knob

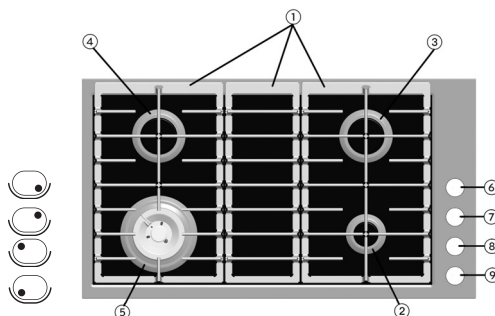

Control Symbols

- Off
- 🔥 Maximum flame
- 🔥 Minimum flame

Using the burners

To turn on one of the burners:

1. Turn the corresponding control knob anticlockwise until the indicator coincides with the maximum flame symbol 🔥.
2. Press the control knob to ignite the burner.
3. Once the burner has lit, keep the control knob pressed for about 5 seconds to allow the safety thermocouple fitted to each burner to engage. The thermocouple will switch off the gas supply to the burner should the flame be accidentally lost (A gust of air, momentary interruption of gas supply or liquid spillage etc).

If the burner does not ignite within about 15 seconds, switch off the burner, check the fitting of the burner cap and plate for correct fitting. Wait at least 1 minute before trying again.

If the burner goes out when the control knob is released, the thermocouple did not engage. wait at least 1 minute before repeating steps 1 to 3.

Practical advice on using the hob

Read the instructions to get the best out of your hob.

- Use pans with a similar diameter to the burner(see the table).
- Use flat bottomed pans except with the wok support.
- Do not use excessive water when cooking foods and use the lid.
- Ensure that pans are fully supported by the pan supports and do not protrude over the edges.

You should never use:

- two burners simultaneously with just one container such as a fish kettle.

<u>Burner</u>	<u>Ø Pans</u>
wok	from 24 to 26 cm
semi fast	from 16 to 24 cm
auxiliary	from 8 to 14 cm

Positioning the pan supports and wok support

Position the pan supports and wok support as indicated in the figure.

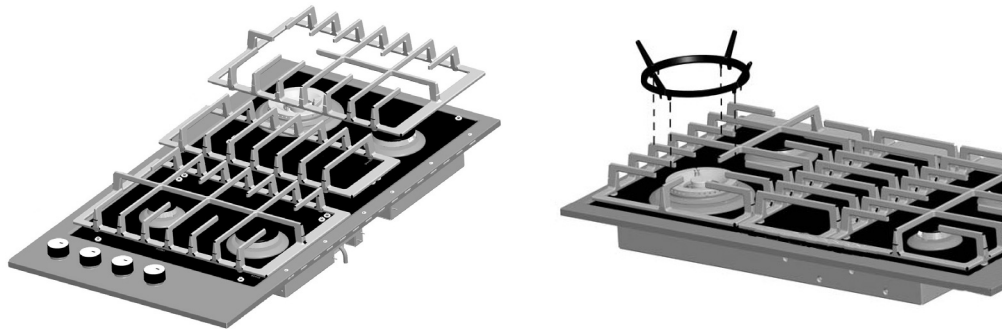

Hood and cabinetry clearances (mm)

If a hood is to be installed above the hob, refer to the hood installation instructions to ensure the correct height above the hob.

Note: If the distance "A" between the kitchen wall cabinets is between 600 and 730 mm, height "B" shall be at least 530 mm.

If the distance "A" between the kitchen wall cabinets is wider than the hob's width, height "B" shall be at least 400 mm.

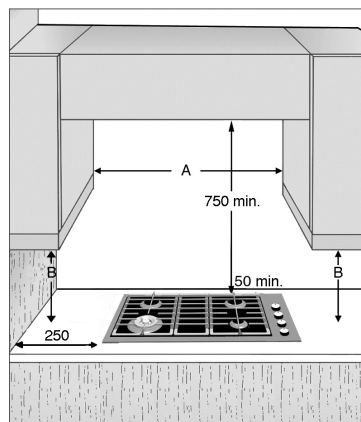

Injector table

Category II2H3+

Type of gas used	Type of burner	Injector label	Control primary air (X) (mm)	Nominal heat flow kW	Nominal consumption	Reduced heat flow kW	Gas pressure (mbar)		
							min.	nom.	max.
NATURAL GAS (Methane) G20	wok semi-fast auxiliary	145	6	4,20	400 l/h	1,40	17	20	25
		95	-	1,65	157 l/h	0,40			
		78	-	1,00	95 l/h	0,30			
LIQUID PETROLEUM GAS (Butane) G30	wok semi-fast auxiliary	100	11	4,20	305 g/h	1,40	20	28-30	35
		65	-	1,65	120 g/h	0,40			
		50	-	1,00	73 g/h	0,30			
LIQUID PETROLEUM GAS (Propane) G31	wok semi-fast auxiliary	100	11	4,20	300 g/h	1,40	25	37	45
		65	-	1,65	118 g/h	0,40			
		50	-	1,00	71 g/h	0,30			

Type of gas used	Configuration model	Nominal heat flow kW	Overall nominal consumption	Required air (m ³) for the combustion 1 m ³ of gas
G20 20 mbar	4 burners	8,5	809 l/h	9,52
G30 28-30 mbar	4 burners	8,5	618 g/h	30,94
G31 37 mbar	4 burners	8,5	607 g/h	23,80

Electric Power: 230 V - 50 Hz

Warnings and suggestions

To get the most out of your hob, please read the instructions carefully and keep them for future consultation.

- These instructions are only valid in the countries whose destination symbol is shown on the serial number plate on the hob.
- The packing (plastic bags, expanded polyurethane, etc) pose a potential threat to children and should be disposed of carefully.
- **Check the appliance has not been damaged during transportation and remove all protective packing and films before installation.**
- **This hob (cat. 3) was designed to be used exclusively for cooking food in household surroundings. Any other use (for example heating rooms) should be regarded as improper and dangerous.**
- **The installation and connection of this appliance to a gas or electrical supply must be carried out by a competent, qualified person in compliance with current legislation.**
- **This appliance should be installed in compliance with standards in force and only used in well ventilated rooms. Read the instructions before installing and using this appliance.**
- **The pre-fitted gas connector and its supply pressure are shown on the label attached to the bottom of the hob. If this type of gas supply is not being used, please refer to the section called Adaption to different types of gas supply on page 11.**

Note:

- Incorrect placement of the pan supports can scratch the hob. To avoid this always ensure that the rubber feet on the bottom of the pan supports are the only part of the pan supports that touch the hob and do not drag the pan supports across the hob surface.
- On the glass surface do not use:
 - Cast iron grills, terracotta pots or pans.
 - Heat convectors (e.g. metal netting).
 - Using two burners to cook 1 pan.
- In the event of prolonged usage, additional ventilation may be required (opening a window or increasing the extraction speed of the hood).

Warning

- Keep children away from the hob when in use and don't let them play with the control knobs or any other part of the appliance.
- Do not let children play with the pan supports. The rubber feet on the underneath of the pan supports could be swallowed by small and cause serious injury or suffocation.
- Before replacing the pan supports on the hob, please check that all the rubber feet are in place.
- Each time you finish using the hob, always check that the control buttons are in the off position and shut off the tap to the gas mains or cylinder.
- Do not obstruct the air vents at the back of the appliance in any way.

Safeguarding the environment

Packing

The packing material is 100% recyclable and is labelled with the recycling symbol . Please dispose of all packing responsibly and carefully.

Product

This appliance is marked according to the European Directive 2002/96/EC, Waste Electrical and Electronic Equipment (WEEE).

By ensuring that this product is disposed of correctly, you will help prevent potentially negative consequences for the environment and human health.



The symbol  on the product, or on the documents accompanying this appliance indicates that this product should not be disposed of as household waste. Please dispose of this appliance at an Electrical & Electronic Equipment Collection point as in accordance with local environmental regulations for waste disposal. For details of your local Collection Point please contact your Local Authority.

Conformity declaration



This hob was designed, built and marketed in compliance with:

- the safety requirements in the "Gas" CEE Directive 90/396
- the safety requirements of "Low Voltage Directive" 2006/95/EC (replacing 73/23/EEC and subsequent amendments)
- the protection requirements of the "EMC" CEE Directive 89/336
- the requirements in CEE Directive 93/68
- this appliance was designed to come into contact with foods and complies with EC Regulation 1935/2004.

Note:

- Incorrect placement of the pan supports can scratch the hob. To avoid this always ensure that the rubber feet on the bottom of the pan supports are the only part of the pan supports that touch the hob and do not drag the pan supports across the hob surface.
- Do not use two burners to cook 1 pan.
- In the event of prolonged usage, additional ventilation may be required (opening a window or increasing the extraction speed of the hood).

Warning

- This appliance is not intended for use by persons (including children) with reduced physical, sensor or mental capabilities or lack of experience and knowledge unless they have been given initial supervision or instruction concerning use of the appliance by a person responsible for their safety.
- **Keep children away from the hob when in use and don't let them play with the control knobs or any other part of the appliance.**
- **Do not let children play with the pan supports. The rubber feet on the underneath of the pan supports could be swallowed by small and cause serious injury or suffocation.**
- **Before replacing the pan supports on the hob, please check that all the rubber feet are in place.**
- **Each time you finish using the hob, always check that the control knobs are in the off position and shut off the tap to the gas mains or cylinder.**
- **Do not obstruct the air vents at the back of the appliance in any way.**

Installation (Flush and Semi-Flush fitting)

Technical information for the installer

- **Warning: this is a heavy products which requires the installation to be carried out by two people.**
 - When installing the hob it is advisable to wear protective gloves.
 - This appliance can be installed into a 20mm - 50mm thick worktop.
 - If no oven is to be installed below the hob, a panel must be fitted under the hob to prevent hob damage and protect the cupboard contents. This panel must cover the whole of the underside of the hob and must be positioned so that an air gap of at least 50mm between the panel and hob underside is maintained, as a minimum, and as a maximum 150mm to the underneath of the work surface.
 - This hob is designed to operate perfectly with any oven in the KitchenAid range. The Manufacturer declines all responsibility should any other make of oven be installed. **The manufacturer declines all responsibility should another make of oven be installed.**
- calibration on the hob are compatible (see serial number plate on the hob and the injector table).
- The cabinetry and appliances surrounding/next to the hob are heat resistant and in compliance with local regulations.
 - The products of combustion are removed from the atmosphere in the room by using an extraction hood or electrical fan installed to the walls and or windows, in line with current regulations.
 - The air circulates naturally through a suitable opening that is no less than 100cm² in cross section, which must be:
 - permanent and accessible on the walls of the room being ventilated and extracting towards the outside.
 - created in such a way that the openings both inside and out cannot be obstructed, even in error.
 - Protected by plastic grill, metallic netting etc. that should not reduce the 100cm² cross section.
 - Located in such a position so as not to interfere with the extraction of the products of combustion.

Before installation, please ensure that:

- The gas supply (type and pressure) and the

Gas connection

Connection to the mains gas system must be carried out by a competent, registered person, in compliance with current legislation.

- The connection of the hob to the gas mains network or gas cylinder must be done using a rigid copper or steel pipe with parts that comply with local standards, or using a flexible stainless steel pipe with continuous surfaces that comply with local standards. The flexible metallic pipe should be no longer than 2 linear metres.
- Before connecting the pipe with the rubber part **(A)**, insert the seal **(B)** is in place (this part, provided complies with **EN549**).

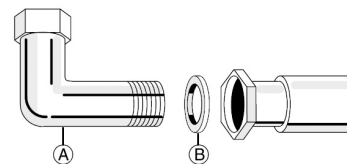

Warning: if you use a stainless steel flexible pipe, it must be installed in such a way that it does not come into contact with moving cabinetry like drawers or kitchen cupboards and passes at a point free of obstacles where it can be examined in its entirety.

- After connecting to the gas mains, use soap and water to check there are no leaks.

Electrical connection

The electrical connections must comply with current legislation and be carried out by a qualified, competent person.

- Information on the voltage and power absorbed are shown on the serial no. plate.
- The appliance must be earthed.
- When installing the appliance, we recommend that this hob is protected by a 3mm bi-polar switch.
- If damaged, the power cable must be replaced with an identical type of power cable (H05V2V2-FT90°C, or H05RR-F type). We recommend that this operation be conducted by our After Sales Service. Please contact our Customer Care Centre on 00800-3810-4026.
- Do not use extension cables.
- The manufacturer declines all responsibility for damage to persons, pets or goods as a result of failure to comply with the regulations above.

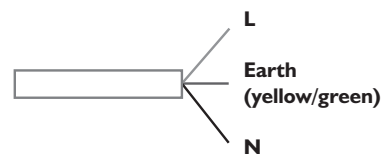

Fixing the Hob to the supporting structure. Traditionally fitted model (Semi Flush fitting).

Important: The following procedure shall be carried out by competent technical personnel only. The hob can be installed on different types of materials, such as masonry, metal, bare wood and heat resistant laminate coated wood (90°C).

Cut an opening in the worktop to the dimensions shown in the diagram.

Carefully place the seal on the external outline of the worktop, as shown in the figure below. Apply a light hand pressure to ensure a good adhesion to the surface.

Fix the hob to the unit, using the fixing brackets provided.

Note: the electrical power cable must be long enough to allow the hob to be lifted out from above.

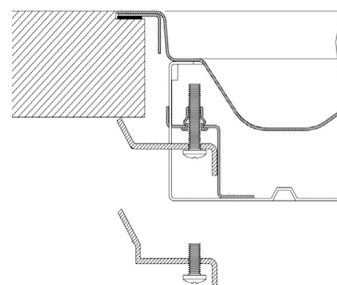
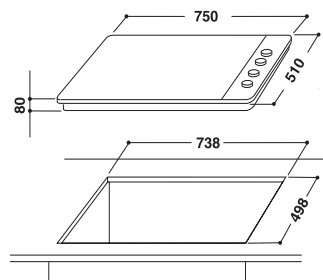

Fixing the Hob to the worktop. Flush fitted model.

Important: The following procedure shall be carried out by competent technical personnel only. The hob can be installed on different types of materials, such as masonry, metal, bare wood and heat resistant laminate coated wood (90°C).

Cut an opening into the worktop to the dimensions shown in the diagram. In order to correctly fit this type of hob, a 3mm deep recess around the edge of the opening is also needed.

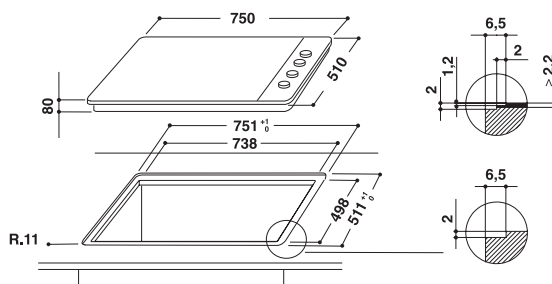

Fig. 1

Note: In case of laminated worktops with a laminate thickness lower than 3 mm, create a recess as shown as on the detailed schematic drawing.

Before positioning the hob, apply the adhesive seal supplied on the bottom perimeter of the hob itself, where this will be in contact with the worktop (fig. 2).



Fig. 2

Once the seal is in position, place the hob in the recess. Fix the hob to the worktop using the screws and brackets provided, tightening them carefully until the hob is perfectly flush. (fig. 3).

Carefully trim the excess seal. In case of installation on wood (particularly chipboard), any small spaces between the edge of the recess and the outside edge of the hob should be filled with small quantities of silicon sealant (see fig. 4). Once the appliance has been installed, the bottom part of the hob should be completely accessible.

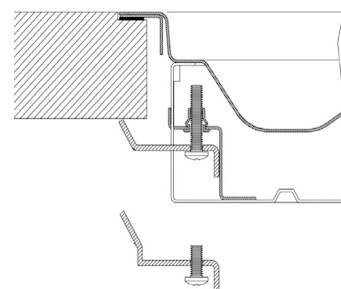

Fig. 3

Important:

- tighten the fixing brackets of the hob to the work top by hand, using minimum force.
- In case of wooden (or similar) worktops, before fitting the adhesive seal protect the surface of the milled recess with a primer.

Slots for extra brackets have been created on the bottom of the appliance, to help achieve a more flush positioning (should this be necessary). Appropriate brackets can be obtained from the Customer Care Centre.

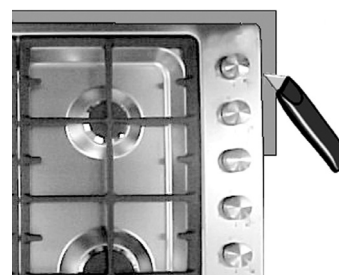

Fig. 4

Adaption to a different type of gas supply

If you are using a different kind of gas from the one indicated on the serial no. plate and the orange label on the back of the hob, you must replace the injectors; in the case of the Wok burner, adjust the primary air (see Injector table on page 6).

The orange label should be removed and kept together with the manual.

Use pressure regulators suitable for the gas pressures indicated on page 6

- In order to replace the injectors, contact the Customer Care Centre on 00800-3810-4026, or a qualified electrician.
- Injectors not supplied as standard should be

requested from the Customer Care Centre on 00800-3810-4026.

- Regulate the minimum levels of the taps.

Note: with liquid petroleum gas (G30/G31) the bypass screw must be screwed in fully. If you then experience difficulty in turning the control knob, contact our After sales Service through our Customer Care Centre on 00800-3810-4026, who will arrange for a replacement after ascertaining that the tap is damaged.

Replacing the injectors

Note: Refer to the injector table to ensure the correct type of injector is to be fitted.

Traditional burners (T)

1. Remove the pan supports (A).
2. Remove the burners (B).
3. Unscrew the injector (C) with a box spanner 7.
4. Replace the injector with the one for the new gas.
5. Replace burners and pan supports.

Note: Before installing the hob, please remember to stick the gas calibration label, provided with the replacement injectors over the gas information on the underside of the hob.

Wok Burner (W)

It is best to change the wok double crown burner before starting installation. However it is necessary:

1. Lift out the hob from the work surface, removing the installation fixing pieces.
2. Remove the screws securing the glass, at the back of the hob plate and those located on both sides of the hob (E).
3. Remove the holding screws that fix the burner to the glass hob. Once you have removed the glass hob, you can access the wok burner injector.
4. Remove the injector (F) using a 10mm spanner.
5. Slacken the holding screw (H) to regulate the position (X) of the gas inlet coupling (G) with regard to the injector.

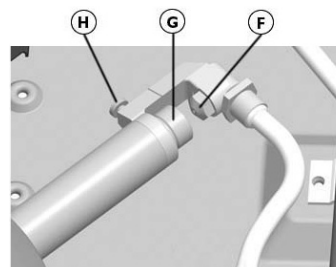
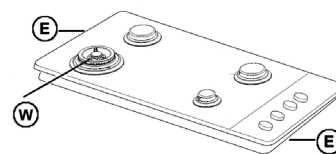
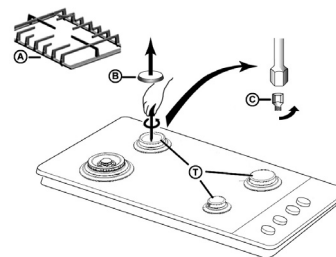

Fitting the wok burner

To fit the double crown wok burner:
Insert in the following order:

1. burner ring (A);
2. decorative covering ring (B);
3. external burner cap (C);
4. internal burner cap (D).

Note: make sure that:

1. the locating pin for the burner ring (A) is inserted correctly in the slot on the burner unit.
2. that the locating pin on the external burner cap (C) is inserted in the slot on the burner ring (A).

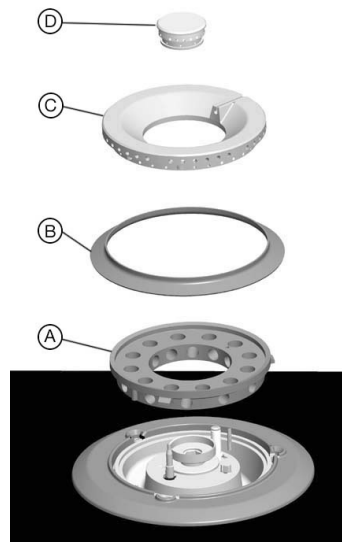



Regulating the minimum flow level of the gas taps

Regulating the minimum flow level must be done with the tap at the lowest position (small flame) .

There is no need to regulate the primary air in the burners.

To ensure the minimum level is properly regulated, remove the control knob and adjust the screws found on the tap as follows:

1. tighten to reduce the height of the flame | (-)
2. slacken to increase the height of the flame (+);
3. With the burners on, rotate the buttons from the maximum  to the minimum position  to check the stability of the flame.

Once you have finished regulating, close up the seals again using sealing wax.

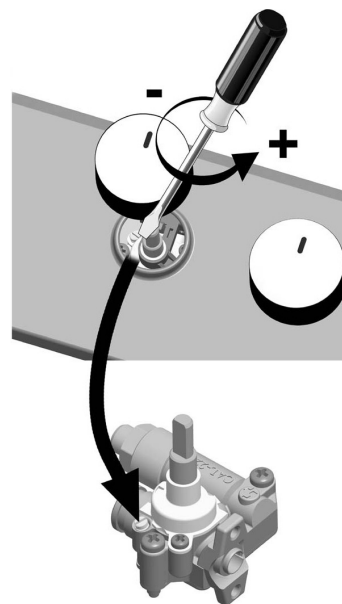

General cleaning & maintenance

Always disconnect the hob from the electrical power supply and wait until it cools before cleaning and/or doing maintenance work. In order to keep your hob in good condition, you must keep it clean, removing any remaining food each time you use it. Cleaning the hob surface:

- the stainless steel surface may become stained if it comes into contact with hard water over a long period of time or with extremely strong cleaning products. Always clean any spillages as quickly as possible (sauce, coffee, etc.). Wash with lukewarm water and a mild detergent, rinse and dry carefully with a soft cloth, or a cloth designed to clean stainless steel. Only use stainless steel cleaning products on the stainless steel trim.
- Do not use harsh or corrosive products, chloride based products or scourers.
- Do not steam clean.
- Do not use inflammable products.

- Do not leave acidic or alkaline based products like vinegar, mustard, salt, sugar or lemon juice lying on the hob, as this will damage the hob and 'etch' the glass surface.

Note: With time, regular use of the hob could cause some discolouration around the burners. This is caused by the high temperature of the flame and will not affect the operation or performance of the hob.

Care and maintenance of the gas burners

The pan supports and burners can be removed to make cleaning easier.

1. Hand wash carefully in hot water with a mild detergent making sure that all the ingrained dirt is removed and the openings on the burner are not blocked. The internal burner cap (**D**), on page 12 is made of brass and is subject to a natural burnishing when it heats up. Clean it each time you use it with a product specifically designed for brass. Use hot water and a mild detergent to clean the wok burner external cap (item **C**) on page 12). Never use harsh products, or scourers that will damage the special surface coverings.
2. Rinse and dry carefully.
3. Correctly refit the burners and caps in their place.
4. Make sure that when replacing the pan supports, the pan support is located correctly for each burner.

Note: Hobs fitted with electronic ignition and thermocouples must have the ends of the igniters and thermocouples cleaned regularly and frequently in order to operate. Please clean them very carefully with a damp cloth. Any remaining ingrained food should be removed carefully with a toothpick, or similar.

To avoid damaging the electronic ignition only operate with the burners and pan supports correctly in place.

Troubleshooting guide

If the hob is not working properly, work through this guide before contacting our Customer Care Centre.

The burner does not ignite, or the flame is unsteady? Check that:

1. the gas, or electricity supply has not been interrupted and that the control knob is turned fully on.
2. the gas supply has not run out.
3. the openings on the burner have become blocked.
4. the end of the electronic igniter is clean.
5. all the parts on the burner are properly positioned.

The flame doesn't stay on? Check that:

1. the button was pushed in properly when turning on the burner for the time required to activate the safety thermocouple.
2. the burner's openings are not blocked near, or around the thermocouple.

3. the end part of the thermocouple is clean.

The pans are not stable? Check that:

1. the bottom of the pan is perfectly flat.
2. the pan is centred on the burner.
3. the pan supports are correctly positioned with all the rubber feet in place.

After Sales Service

Before contacting our Customer Care Centre please check to see if the problem can be fixed by referring to the troubleshooting guide.

1. If the fault persists contact us on 00800-3810-4026. We will ask you for some information, it will help us, help you if you have the following information ready to give us:
 - a short description of the fault
 - the serial number and model number of the appliance
 - the service number (the number after the word service on the rating plate on the bottom of the hob. The service number can also be found in the warranty booklet.

- your name, full address including postcode and telephone number.



Note: If there is a problem with your hob, failure to contact us could seriously compromise the safety and quality of this appliance.

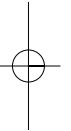
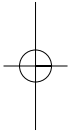

Whirlpool Europe S.r.l.

Viale G. Borghi, 27 - 21025 Comerio (VA)
Phone 0332.759111 - Fax 0332.759268
www.whirlpool.eu

Printed in Italy
06/07

5019 719 01132

GB

