

**Gebrauchsanweisung**

Instructions for use

**Mode d'emploi**

Gebruiksaanwijzing

**Istruzioni per l'uso**

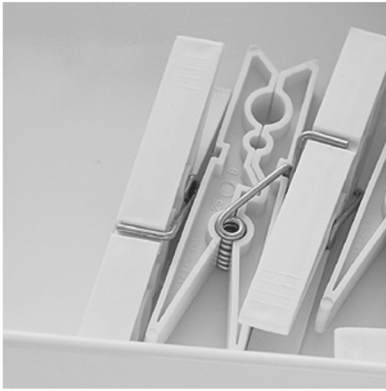

**Brugsanvisning**

Bruksanvisning

**Käyttöohje**

Manual de utilização

**Instrucciones para el uso**



**Οδηγίες χρήσης**

Instrukcje użytkowania

**Használati utasítás**

**Инструкция за употреба**



**Návod k použití**

Návod na použitie

**Instrucțiuni de utilizare**

**Инструкции по эксплуатации**

# CONTENTS

## QUICK REFERENCE GUIDE



PLEASE READ INSTRUCTIONS  
FOR USE BOOKLET!

### PROGRAMME CHART

PREPARING THE LAUNDRY

SELECTING A PROGRAMME AND OPTIONS

STARTING AND COMPLETING A PROGRAMME

CHANGING A PROGRAMME

INTERRUPTING A PROGRAMME

DAILY MAINTENANCE AND CLEANING

## INSTRUCTIONS FOR USE

### BOOKLET

BEFORE USING THE DRYER	Page 3
PRECAUTIONS AND GENERAL RECOMMENDATIONS	Page 5
ELECTRICAL CONNECTION	Page 7
DESCRIPTION OF THE DRYER	Page 8
REMINDER - MAINTENANCE AND CLEANING	Page 8
CLEANING THE LINT FILTER	Page 8
CLEANING THE HEAT EXCHANGER	Page 9
DRAINAGE SYSTEM	Page 10
DOOR REVERSIBILITY	Page 11
TROUBLESHOOTING GUIDE/ AFTER-SALES SERVICE	Page 12

# BEFORE USING THE DRYER

- This dryer is exclusively designed to dry machine dryable laundry in quantities which are usual for private households.
- Observe the instructions given in these Instructions For Use and the Programme Chart before using the dryer.
- Keep the Instructions For Use and the Programme Chart handy for reference. If you pass on the dryer to others, make sure that the Instructions For Use and the Programme Chart go with it.
- The manufacturer declines all liability for damage to property or injury to persons or animals due to non-compliance with the directions given in these Instructions For Use.

## 1. Removing the packaging and inspection

- After unpacking, make sure that the dryer is undamaged. If in doubt, do not use it. Contact the After-Sales Service or your local retailer.
- If the appliance was exposed to the cold prior to delivery, keep it at room temperature for a few hours before operating.
- Do not operate the dryer if it has been damaged during transport. Contact one of our After-Sales Service technicians.

## 2. Electrical Connections

- Electrical connections must be carried out by a qualified technician in compliance with the manufacturer's instructions and current standard safety regulations.
- Electrical connections must comply with local Electricity Board regulations.
- Data regarding voltage, power consumption and the required fuse protection is shown on the rating plate mounted at the rear of the dryer.
- The dryer must be earthed as prescribed by law.
- Before carrying out any maintenance on the dryer disconnect it from the mains supply.
- Mains cable replacement must only be carried out by the After-Sales Service.
- After installation, access to the mains plug or to an all-pole disconnection switch must be ensured at all times.
- Light bulb replacement must only be carried out by the After-Sales Service.

## 3. Installation

- Do not install your dryer where it may be exposed to extreme conditions, such as: poor ventilation, temperature below 5°C or above 35°C.
- The appliance must not be installed behind a lockable door, a sliding door or a door with hinges on the opposite side to that of the tumble dryer, in such a way as to prevent the tumble dryer door from being fully opened.

- Small indoor located storage rooms, bathrooms, toilets, shower rooms and enclosed areas without ventilation are not suitable locations for installation of the dryer. If it must be installed in such a location, adequate ventilation must be ensured (open doors, ventilation grid or slot larger than 500 cm<sup>2</sup>).
- Before running the first cycle, ensure that the water container is fully pushed inside and that the heat exchanger is correctly positioned.

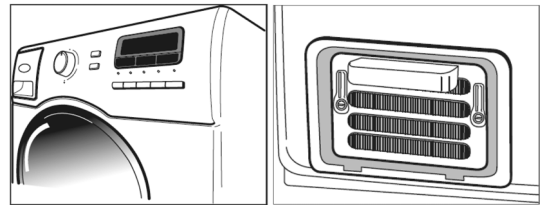

- Before running the first cycle, ensure that all of the drainage system hoses are connected (as shown in the picture below).

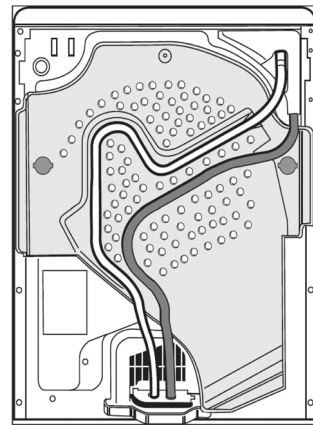

- If possible use a hose to drain the water directly into the domestic plumbing system. This will avoid having to empty the water container at the end of each drying cycle, since the condensation water can be directly drained away. Also see section entitled "Drainage System".
- Take care not to install the dryer on a deep-pile carpet.
- Take care not to trap the mains cable between the dryer and the wall.
- When installing the dryer make sure that the four feet are stable and resting on the floor, adjusting them as required, and check that the machine is perfectly level using a spirit level.
- If, due to lack of space, the dryer must be installed directly next to a gas or coal stove, a heat insulating plate (85 x 57cm) must be installed in between and the side of the plate facing the stove must be covered with aluminium foil.

- The dryer is not designed for built-in installation.
- The dryer can be installed under a worktop, provided that adequate ventilation of the dryer is assured. Install a ventilation grid (minimum 45 cm x 8 cm), in the rear part of the worktop under which the dryer is installed.

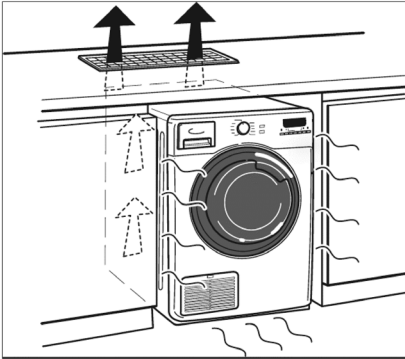

#### 4. Assembly of distance holders

To ensure that the appliance is positioned at a correct distance from the wall at the rear side and to allow sufficient ventilation, distance holders must be mounted on the rear side of the dryer before starting the first drying cycle.

- Remove the two distance holders from the packaging.
- The distance holders must be inserted on the rear side of the dryer in the protective cover.

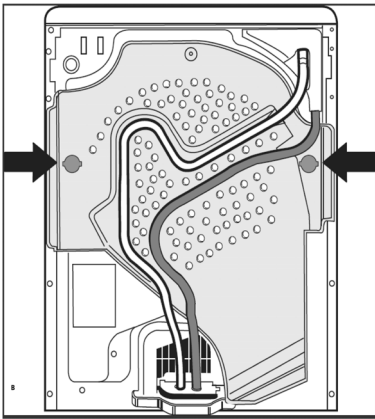

**B**

- Insert the distance holders in the holes provided on both sides.

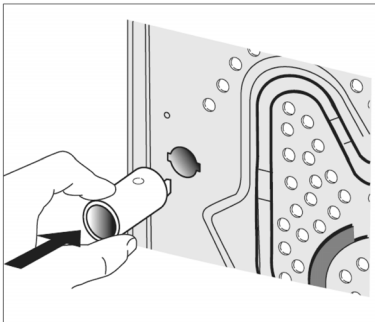

**C**

- Secure both distance holders by turning them in a clockwise direction as far as the stop position.

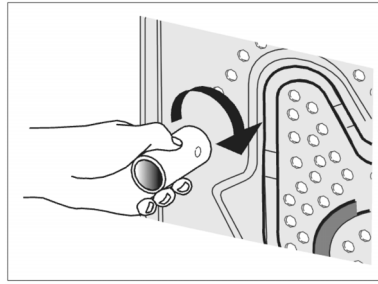

**D**

#### 5. User and child protection

- Children must not be allowed to play with the dryer.
- Ensure that children and small animals cannot get into the drum.
- Keep the packaging materials (plastic bags, polystyrene parts, etc.) out of reach of children, as they are potentially dangerous.
- The appliance is not intended for use by persons (including children) with reduced physical, sensory or mental capabilities, or lack of experience and knowledge, unless they have been given supervision or instruction concerning use of the appliance by a person responsible for their safety. Children should be supervised to ensure that they do not play with the appliance.

#### Stacking kit

- Depending on the model, your dryer can be stacked on top of your front loading washing machine. For further information please contact the After-Sales Service.



# PRECAUTIONS AND GENERAL RECOMMENDATIONS



**To minimise the risk of fire in the tumble dryer, the following precautions should be observed:**

- Oil-soaked items ignite spontaneously, especially when exposed to heat sources such as in a tumble dryer. The items become warm, causing an oxidation reaction in the oil. Oxidation creates heat. If the heat cannot escape, the item can become hot enough to catch fire. Piling, stacking or storing oil-soaked items can prevent heat from escaping and so create a fire hazard.
- Do not dry unwashed items in the tumble dryer.
- Ensure that the appliance is maintained as shown in the section “Maintenance and cleaning”.
- Ensure that the appliance is installed as per the instructions above.
- Items that have been soiled with substances such as cooking oil, acetone, alcohol, petrol, kerosene, spot removers, turpentine, waxes and wax removers must be washed in hot water with an extra amount of detergent before being dried in the tumble dryer.
- Do not use flammable cleaning agents.
- Do not use the tumble dryer if chemicals have been used for cleaning.
- Items such as foam rubber (latex foam), shower caps, waterproof textiles, rubber backed articles and clothes or pillows fitted with foam rubber pads must not be dried in the tumble dryer.
- Fabric softeners or similar products should be used as specified in the fabric softener instructions.
- Remove all objects from pockets, such as lighters and matches.
- Never use or store flammable materials near to the dryer.
- Never stop a tumble dryer before the end of the drying cycle, unless all items are quickly removed and spread out so that the heat is dissipated.
-  Warning: rear panel may be hot.
- The dryer is suitable for indoor use only.
- Do not use extension leads or multiple adaptors.

- Always set the programme/time selector knob to the “0” position after use. This prevents the dryer from being switched on accidentally.
- Before cleaning or carrying out maintenance, switch off the dryer and disconnect it from the mains supply.
- To clean the outside of the dryer, use a neutral detergent and a damp cloth.
- Do not use abrasive detergents.
- The final phase of a drying cycle always occurs without heat (cool-down phase) so that the items are left at a temperature which ensures that they will not be damaged.
- Wipe away any lint from the door seal and the door using a damp cloth.
- If the lint filter mesh is clogged, clean it with water and a soft brush.
- Since lint can penetrate through the filter, it is necessary to clean the entire filter area (including below the filter) from time to time using a brush, a damp cloth or a vacuum cleaner.

## EC Declaration of Conformity

- This dryer has been designed, constructed and distributed in compliance with the safety requirements of EC Directives:
- 2006/95/EC Low Voltage Directive
- 2004/108/EC Electromagnetic Compatibility Directive
- 
- This appliance is marked according to the European directive 2002/96/EC on Waste Electrical and Electronic Equipment (WEEE).
- By ensuring that this product is disposed of correctly, you will help prevent potential negative consequences for the environment and human health, which could otherwise be caused by inappropriate waste handling of this product.



## Packaging

- The packaging box is 100% recyclable, as confirmed by the recycling symbol.

## Disposing of packaging and old appliances

- The dryer is built from reusable materials. The dryer must be disposed of in compliance with local waste disposal regulations.
- Before scrapping cut off the power cable so that the dryer cannot be connected to the mains.



- The symbol  on the product or on the documents accompanying the product indicates that this appliance must not be treated as household waste. Instead it should be handed over to the applicable collection point for the recycling of electrical and electronic equipment. Disposal must be carried out in accordance with local environmental regulations for waste disposal.
- For more detailed information about treatment, recovery and recycling of this product please contact your local city council office, your household waste disposal service or the shop where you purchased the product.

## Energy saving tips

- Always dry a full load, depending on the type of laundry and the programme/drying time. For more detailed information, see the programme chart.
- By preference use the maximum spin speed allowed by your washing machine, since draining the water mechanically requires less energy. You will save time and energy when running your drying cycle.
- Do not overdry the laundry.
- Clean the lint filter after every drying cycle.
- Clean the heat exchanger every month.
- Place your dryer in a room with a temperature between 15°C and 20°C. If the temperature is higher then ventilate the room, e.g. by opening the window.
- Always select the correct programme/drying time for the load in order to obtain the desired drying results.
- Select the 'Gentle' option only in case of drying small loads.
- When drying cotton, for example, dry Iron Dry and Cupboard Dry loads together. Start with the Iron Dry programme/drying time setting, remove the laundry to be ironed at the end of that cycle and dry the remainder of the load on the Cupboard Dry setting.

- Always set the program selector knob to the "0" position after the end of the cycle.

# ELECTRICAL CONNECTION

## 1) For United Kingdom only

**Warning - this appliance must be earthed**

### Fuse replacement

If the mains lead of this appliance is fitted with a BS 1363A 13amp fused plug, to change a fuse in this type of plug use an ASTA marked fuse, approved to BS 1362 and proceed as follows:

1. Remove the fuse cover (A) and fuse (B).
2. Fit replacement 13A fuse into fuse cover.
3. Refit both into plug.

### Important:

The fuse cover must be refitted when changing a fuse. If the fuse cover is lost, the plug must not be used until a correct replacement is fitted.

Correct replacements are identified by the colour insert or by the colour embossed in words on the base of the plug.

Replacement fuse covers are available from your local electrical store.

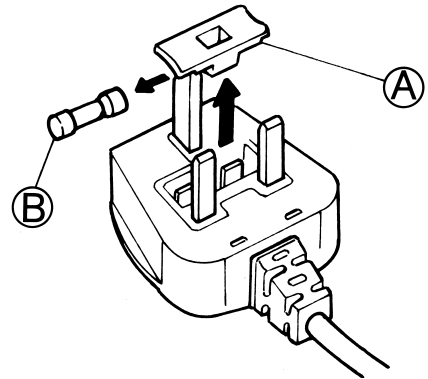

## 2) For the Republic of Ireland only

The information given in respect of United Kingdom will frequently apply, but a third type of plug and socket is also used, the 2-pin type with side earth terminal.

## 3) Socket outlet / plug (valid for both countries)

If the fitted plug is not suitable for your socket outlet, please contact Whirlpool Service for further instructions. Please do not attempt to change the plug yourself. This procedure must be carried out by a qualified Whirlpool technician in compliance with the manufacturer's instructions and current safety regulations.

# DESCRIPTION OF THE DRYER

- A. Work top
- B. Water container
- C. Contact pin
- D. Door:  
To open the door, pull the handle.  
To close the door, push gently until closed.
- E. Filter
- F. Heat exchanger
- G. Heat exchanger flap

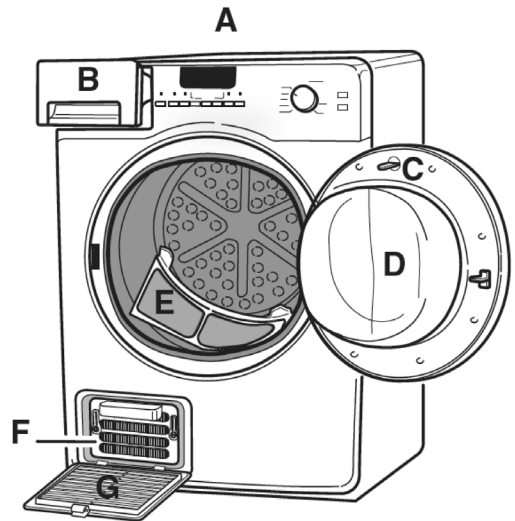

## REMINDER - MAINTENANCE AND CLEANING

Before cleaning or carrying out maintenance, switch off the dryer.

### AFTER EACH DRYING CYCLE

- Clean the lint filter at the end of every drying cycle.
- Empty the water container at the end of each drying cycle.

### EACH MONTH

- Clean the heat exchanger at least every month (see “Cleaning the heat exchanger” on the next page).

## CLEANING THE LINT FILTER

Depending on the model of your dryer, the lint filter can have different shapes.

Clean the lint filter after every drying cycle, or when the lint filter indicator lamp lights up, proceeding as follows:

- A. Take the lint filter out of the dryer and carefully open the filter.
- B. Carefully remove the complete lint from the lint screen.

When the lint filter is clean, put it back into the dryer. Make sure that the lint filter is correctly positioned before starting the next drying cycle.

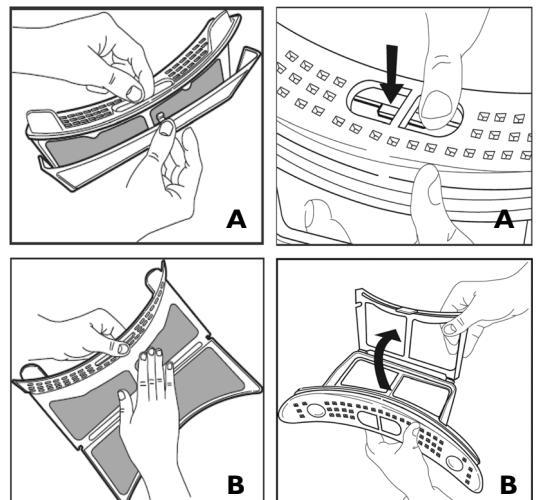



# CLEANING THE HEAT EXCHANGER

**Before cleaning or carrying out maintenance, switch off the dryer. Clean the heat exchanger at least every month, or whenever the heat exchanger indicator lamp lights up (optional feature, depending on the model of your dryer), proceeding as follows.**

- A.** Open the heat exchanger flap and put it to one side.

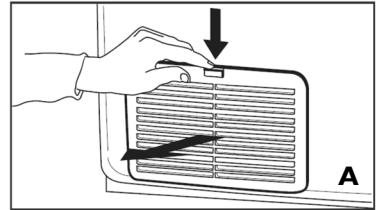

- B.** Turn the two locking bars at the side of the heat exchanger towards the middle, to the horizontal position, and pull the heat exchanger out.

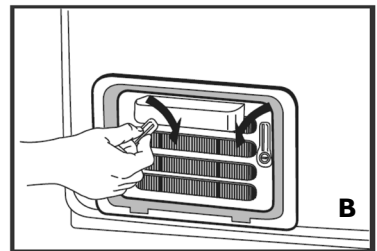

- C.** Hold the heat exchanger as shown in the picture. Clean it under running water by turning it around to reach all sides, especially in front and behind. Wipe away dust and lint from the heat exchanger seals and plates. Clean the inside of the heat exchanger plates under running water, from the front side to the back.

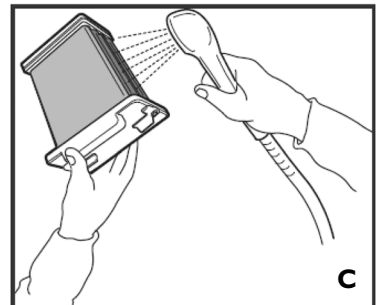

- D.** Remove the lint from the heat exchanger housing by hand or with a damp cloth. Clean the entire housing from the back to the front side, ensuring that all lint is removed.

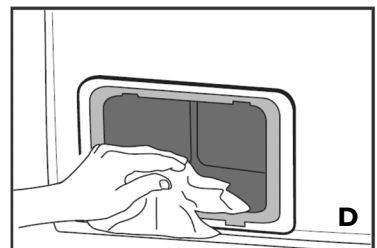

- Fully insert the heat exchanger back into the housing (TOP or HAUT mark upwards) and lock it again by turning the locking bars back to their original position.
- The heat exchanger does not need to be dry when it is reinserted after cleaning.
- Insert and latch the flap again. The flap can only be closed if the heat exchanger is correctly positioned.
- The heat exchanger indicator lamp will switch off automatically when you start the next drying cycle.

The heat exchanger aluminium plates may become discoloured over time, depending on the model of your dryer.

# DRAINAGE SYSTEM

**For your convenience:**

**The dryer can be connected directly to the sewage system of the house to avoid having to empty the water container after each drying cycle.**

Place an absorbent cloth underneath to collect water spillage.

- A.** Unplug the hose located at the upper rear part of the dryer.

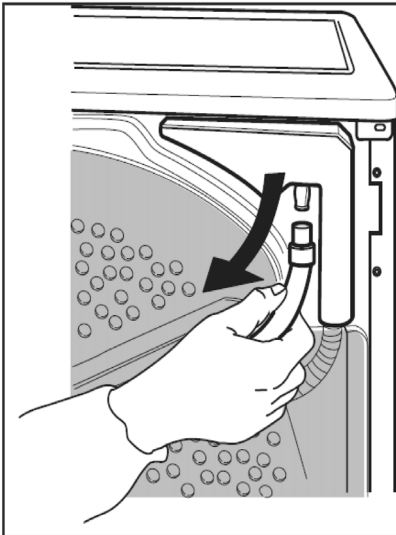

- B.** Remove the hose from the rear protective cover.

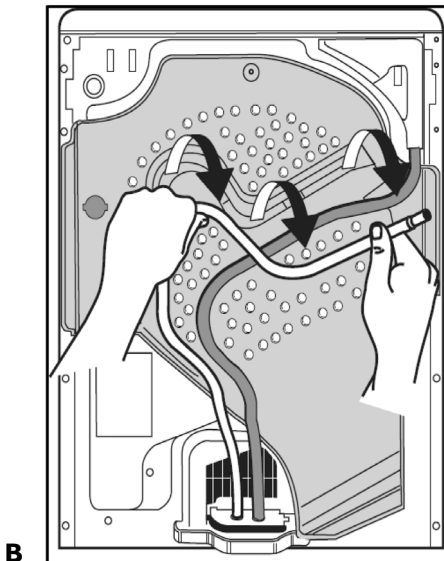

- C.** Connect the hose to the sewage system. The height difference between the floor where the dryer is positioned and the sewage system connection should not exceed 1 m.

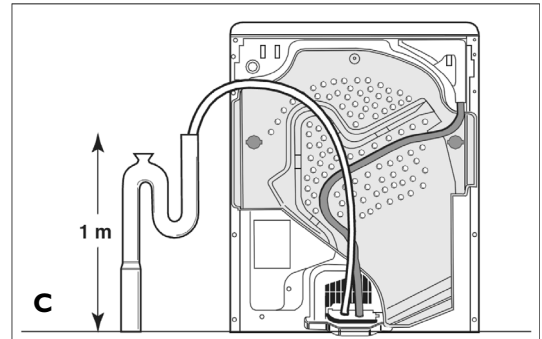

**Notice:** To prevent water siphoning back into the appliance, the end of the hose must not be immersed in the drain water. Avoid bending and twisting the hose.

# DOOR REVERSIBILITY

For your convenience:

In case you want to stack the dryer on a washing machine, you can reverse the door opening direction, to lower the position of the door handle.

Unplug the dryer.

A. Open the door.

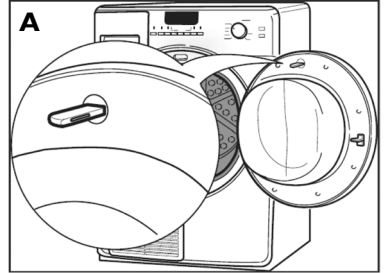

B. Using a spanner, turn the contact pin (B) in the top part of the door through 90° and pull it out.

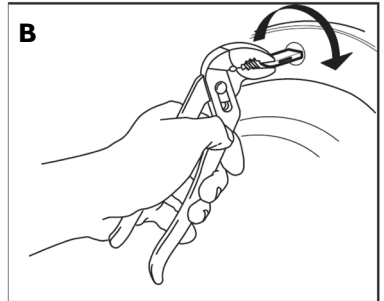

C. Remove the door lock:  
Unscrew the 2 screws above and below the door lock system.

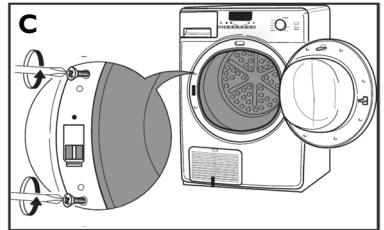

D. Press the small knob above the door lock system with a small screwdriver, move the door lock slightly upwards and pull the door lock towards you with your finger.

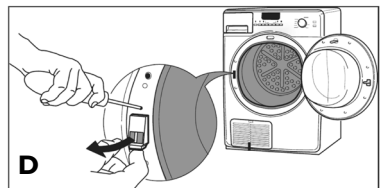

E. Reverse the door:  
Remove the two screws of the door fixing plate. Fasten the door again on the desired side with the 2 screws. Take care to tighten the screws horizontally to avoid pinching off the door seal.  
Reposition the door lock:  
Insert the door lock on the opposite side of the door fixing plate. Press it fully into the hole and move it downward slightly, until the small knob of the door lock system latches in position. Fasten the two screws above and below the door lock system.  
Now reinsert the contact pin on the inside of the door, at the top, by inserting it and turning it again through 90°.

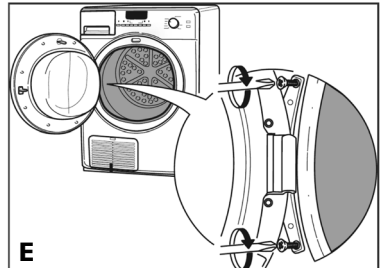

**NOTE:** Ideally you should use a Torx T20 type screwdriver to undo and tighten the screws.

# TROUBLESHOOTING GUIDE/ AFTER-SALES SERVICE

In the event that the dryer malfunctions, one of the following failure codes may be displayed. Depending on the model of your dryer, the failure may be displayed in letters or by different blinking LEDs.

Failure code	LED failure code	Check to be carried out by customer before service call
<b>F01</b>		Please call the After-Sales Service.
<b>F02</b>		Please call the After-Sales Service.
<b>F03</b>		Please call the After-Sales Service.
<b>F04</b>		Please call the After-Sales Service.
<b>F05</b>		Turn the dryer OFF and unplug it. Make sure that the ambient temperature is between 5°C and 35°C. Wait for 1 hour. Plug the dryer back in and restart it. If the failure reoccurs, please call the After-Sales Service.
<b>F06</b>		Turn the dryer OFF and unplug it. Make sure that the ambient temperature is between 5°C and 35°C. Wait for 1 hour. Plug the dryer back in and restart it. If the failure reoccurs, please call the After-Sales Service.
<b>F07</b>		Please call the After-Sales Service.
<b>F10 - 15</b>	Turn the dryer OFF and unplug it. Wait for 5 minutes. Plug the dryer back in and restart it. If the failure reoccurs, please call the After-Sales Service.	
<b>F18</b>	Turn the dryer OFF and unplug it. Wait for 1 hour. Plug the dryer back in and restart it. If the failure reoccurs, please call the After-Sales Service.	
<b>F19</b>	Turn the dryer OFF and unplug it. Wait for 5 minutes. Plug the dryer back in and restart it. If the failure reoccurs, please call the After-Sales Service.	
<b>F20</b>	Turn the dryer OFF and unplug it. Wait for 1 hour. Plug the dryer back in and restart it. If the failure reoccurs, please call the After-Sales Service.	
<b>F21</b>	Turn the dryer OFF and unplug it. Wait for 5 minutes. Plug the dryer back in and restart it. If the failure reoccurs, please call the After-Sales Service.	
<b>F22</b>	Turn the dryer OFF and unplug it. Wait for 5 minutes. Plug the dryer back in and restart it. If the failure reoccurs, please call the After-Sales Service.	
<b>Start LED blinks 2 times per second when pressed</b>	Make sure that the door is correctly closed and the heat exchanger correctly positioned. If the failure reoccurs, please call the After-Sales Service.	
<b>Heat exchanger LED blinks 2 times when Start button is pressed</b>	Make sure that the heat exchanger is correctly positioned. If the failure reoccurs, please call the After-Sales Service.	



# TROUBLESHOOTING GUIDE/ AFTER-SALES SERVICE

**If a fault occurs, before contacting our After-Sales Service, perform the following checks to try to remedy the problem:**

## **Drying takes too long / laundry is not dry enough:**

- Correct programme selected?
- Laundry too wet (Washing machine spin speed less than 1000 rpm? When the spin speed is less than 1000 rpm a water container fault may occur during the drying cycle).
- Lint filter clogged (filter indicator lamp on?)
- Heat exchanger clogged? (refer to the sections "CLEANING THE LINT FILTER/CLEANING THE HEAT EXCHANGER").
- Is the ambient temperature too high?
- END indicator lamps on? The drying cycle is complete and the laundry can be taken out.
- 'Gentle' option selected? The 'Gentle' option should only be selected with small loads.
- Mixed laundry load (for example cotton and synthetics).

## **The dryer does not operate:**

(after a power failure and/or interruption to the mains supply, always press the "**Start (Pause)**" button).

- Plug connector properly inserted into the mains electricity socket?
- Power failure?
- Fuse blown?
- Door properly closed?
- Drying programme selected?
- Start delay option selected?
- "**Start (Pause)**" button activated?
- Indicator lamps are lighting up?

## **Lint filter, water container or heat exchanger indicator lamp on:**

- Lint filter clean?
- Water container empty?
- Water container correctly positioned?
- Heat exchanger clean and correctly positioned?

## **Water droplets underneath the dryer:**

- Heat exchanger correctly positioned?
- All lint on the heat exchanger seal removed?
- All lint on the door seal removed?
- Water container positioned correctly?
- Dryer levelled?

## **After-Sales Service**

**If, after carrying out the above checks, the malfunction persists or reoccurs, turn the dryer off and call the After-Sales Service (refer to warranty).**

### **Please specify:**

- The nature of the fault.
- The dryer type and model.
- The service code (the number after the word Service on the adhesive rating plate) on the lower side of the door opening.
- Your full address and phone number.

**SERVICE** 0000 000 00000

