



**FORNO DA INCASSO
HORNO EMPOTRABLE
FORNO DE ENCASTRAR
ENTOIXIZOMENOS ΦΟΥΡΝΟΣ
FOUR ENCASTRABLE
BUILT-IN OVEN**

- IT** Manuale d'uso e manutenzione
- ES** Manual de uso y mantenimiento
- PT** Manual de utilização e manutenção
- GR** Εγχειρίδιο χρήσης και συντήρησης
- FR** Guide d'utilisation et d'entretien
- EN** User and maintenance manual

The Whirlpool logo consists of a stylized swirl icon above the brand name 'Whirlpool' in a bold, sans-serif font.

SENSING THE DIFFERENCE

1

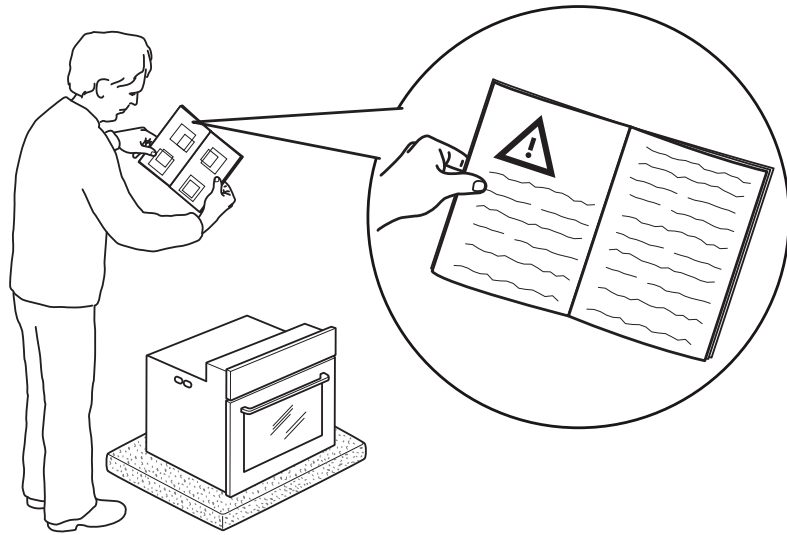

2

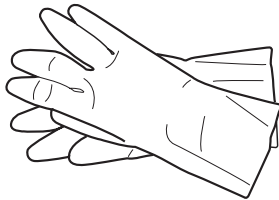
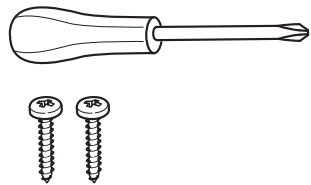

3

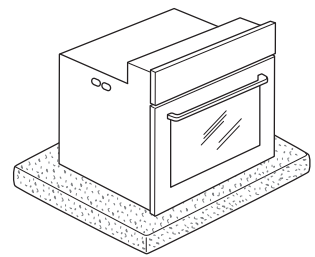
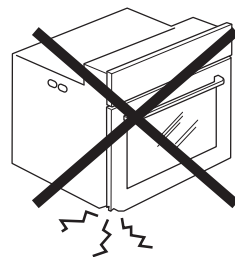

4

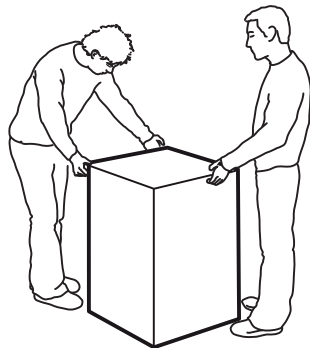
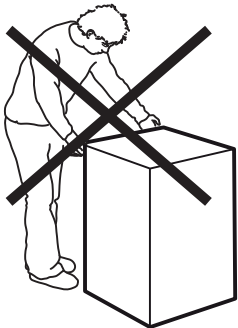

5

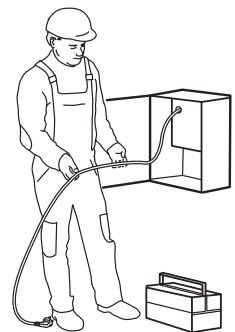
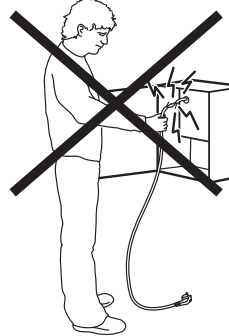

6

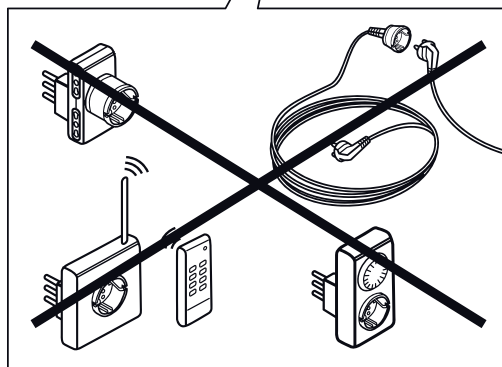
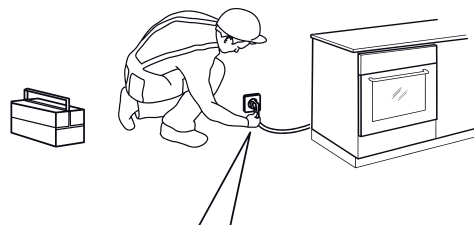
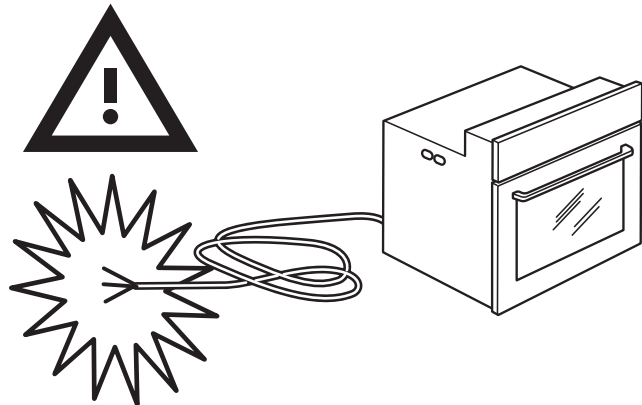

7

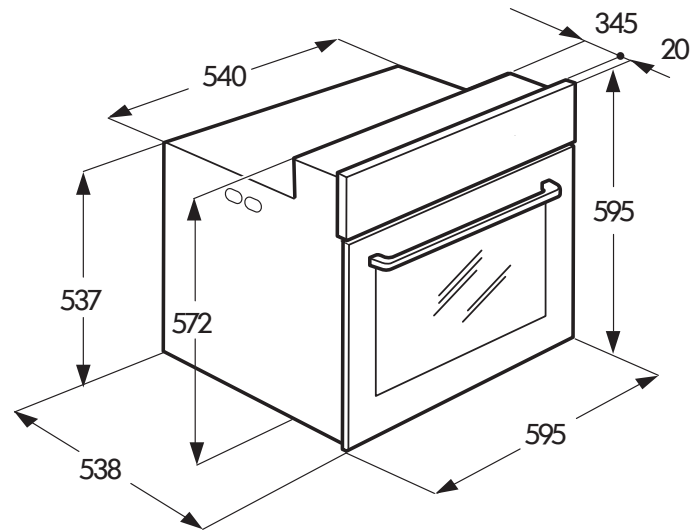

8

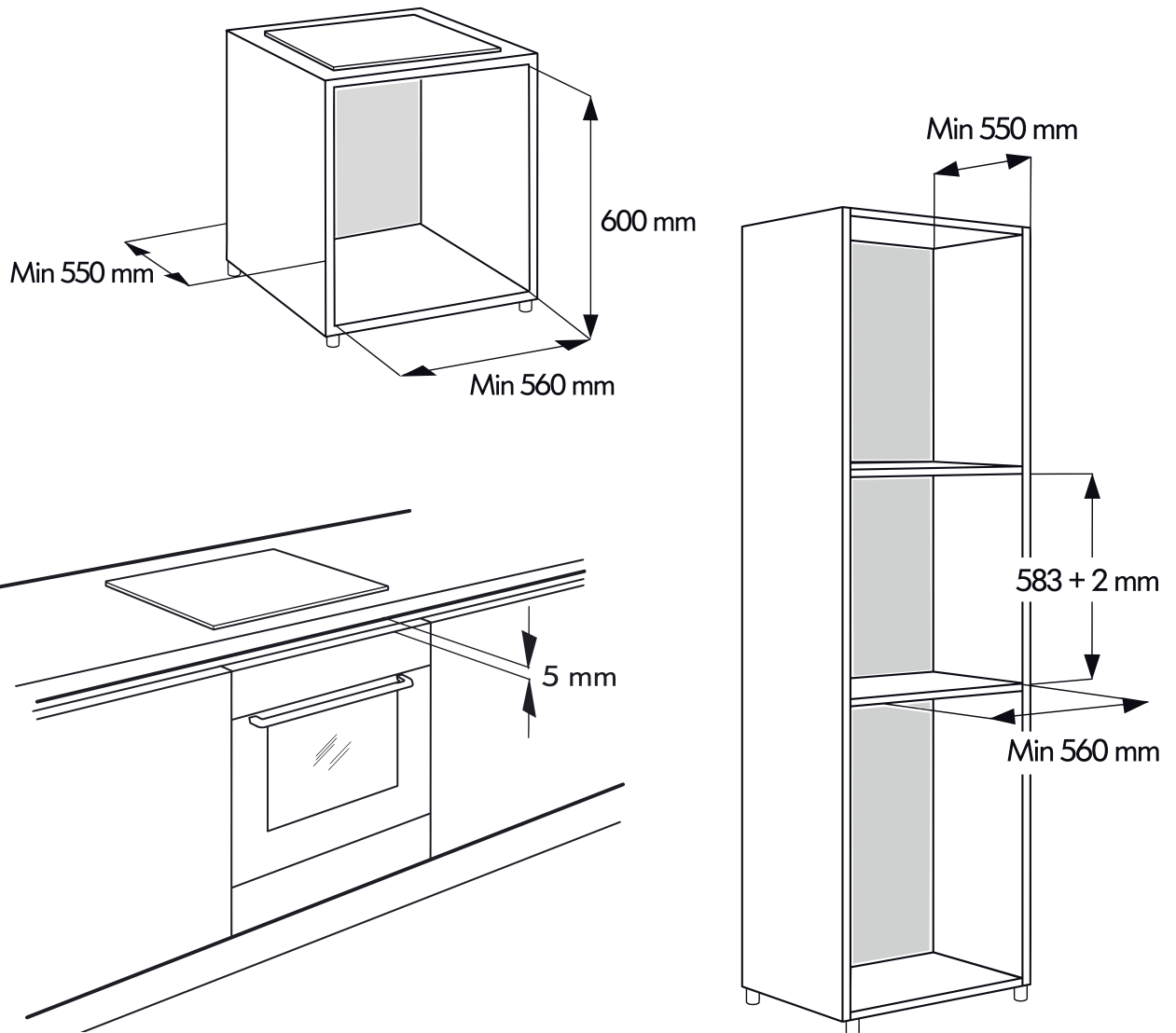

SOLO modelli con funzione di PIROLISI
 SÓLO para hornos con función de PIRÓLISIS
 APENAS fornos com função de limpeza PIROLÍTICA
 MONO για φούρνο με λειτουργία ΠΥΡΟΛΥΣΗΣ
 UNIQUEMENT pour les fours dotés de la fonction PYROLYSE
 ONLY for models with PYROLITIC cleaning function



9

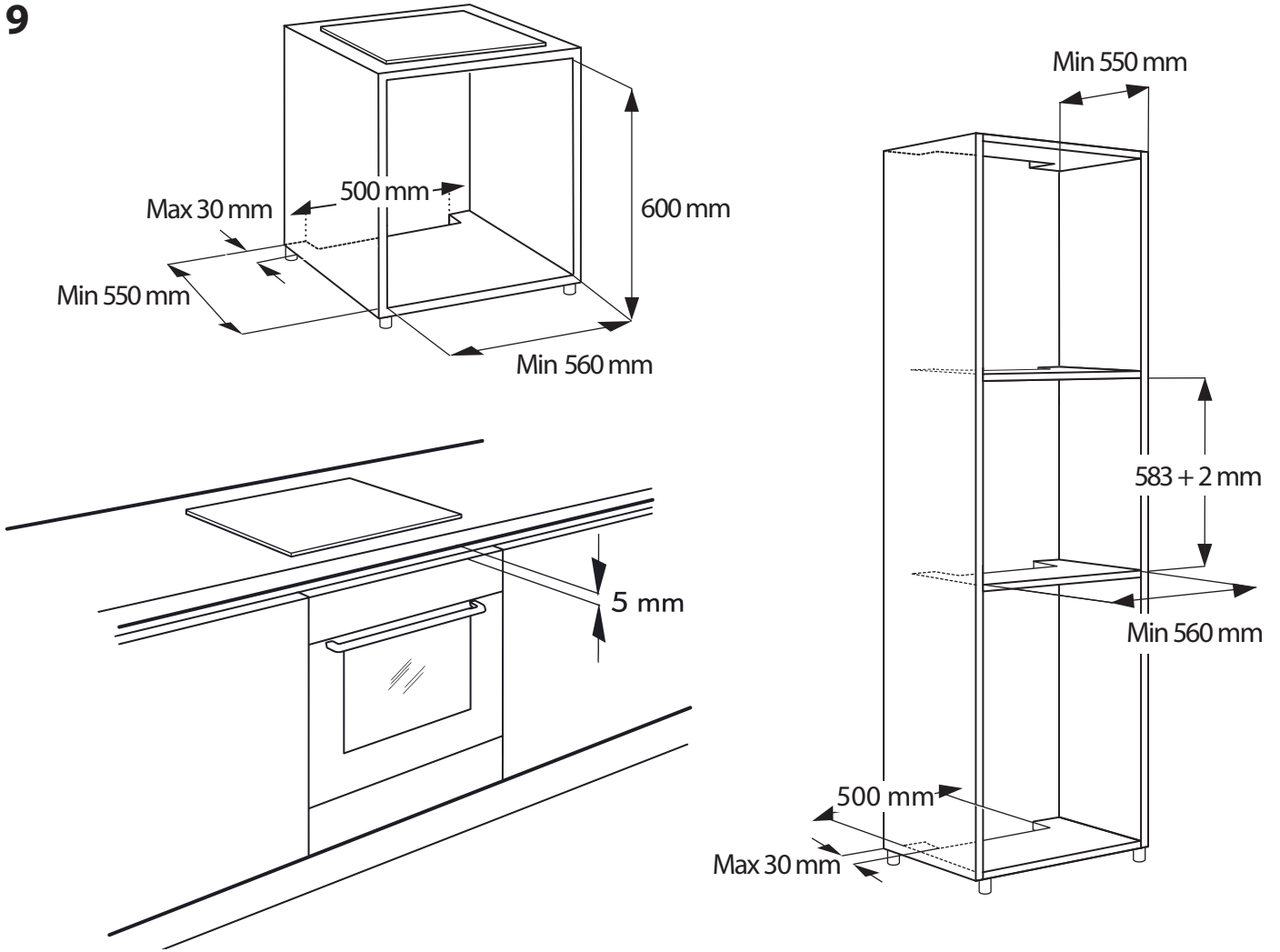

10

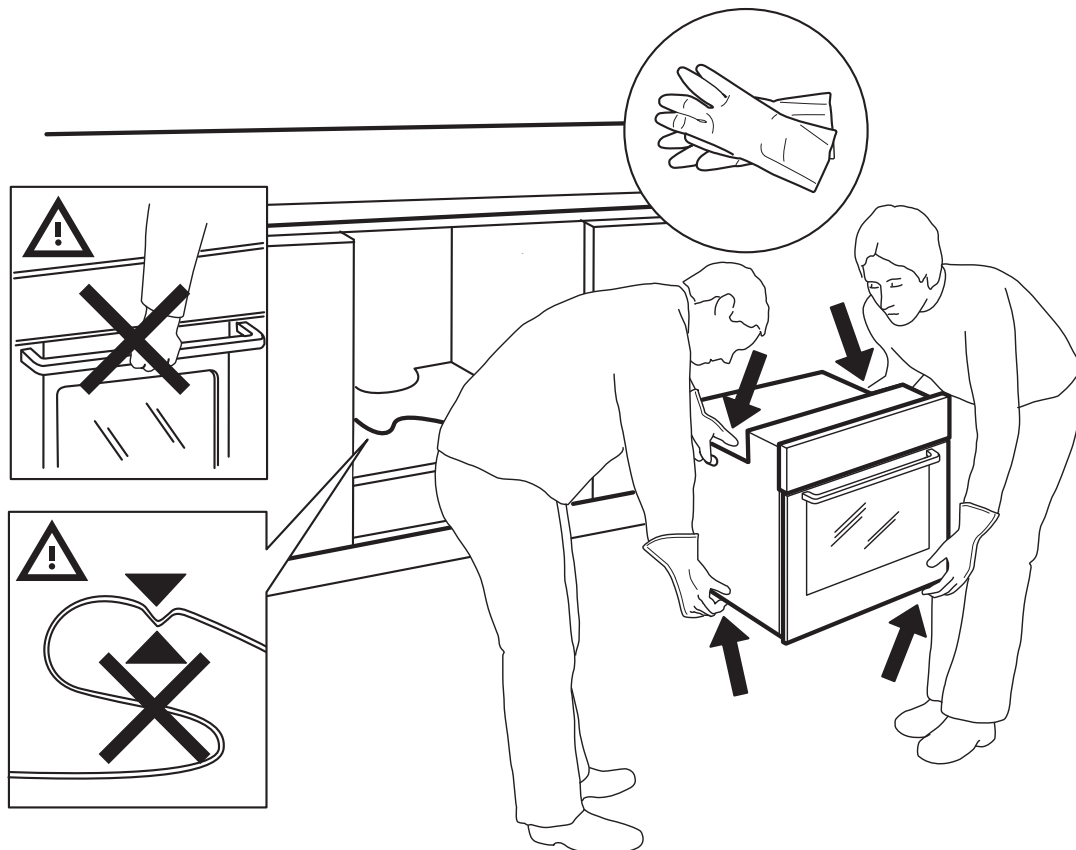

11

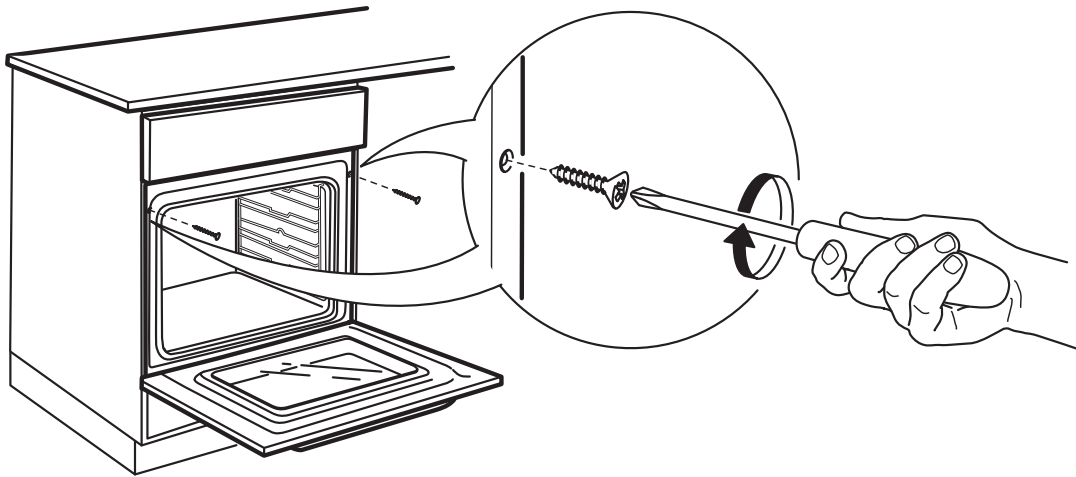
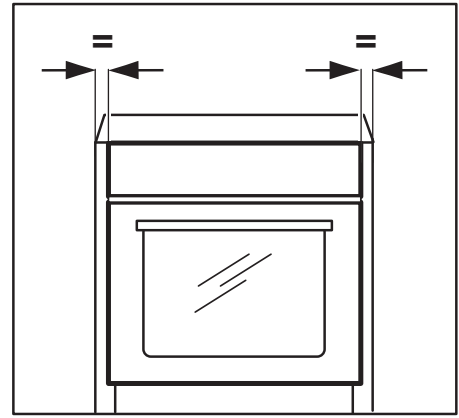
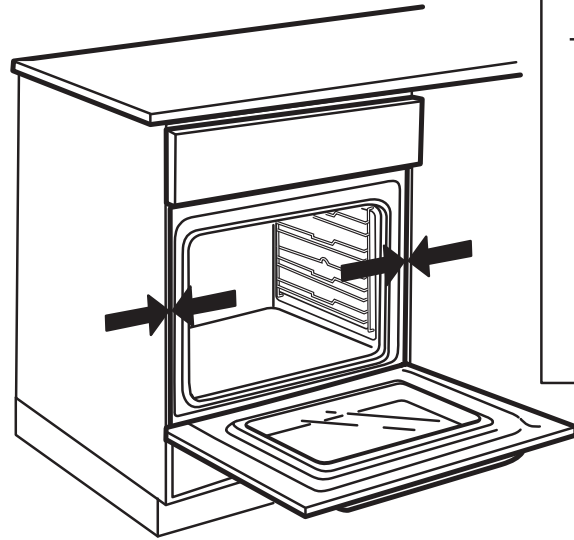

LANGUAGES	
	IT PAGE
	ES PAGE
	PT PAGE
	GR PAGE
	FR PAGE
	EN PAGE

TABLE OF CONTENTS	
INSTALLATION INSTRUCTIONS	2
IMPORTANT SAFETY INSTRUCTIONS	2
DECLARATION OF CONFORMITY	5
SAFEGUARDING THE ENVIRONMENT	5
INSTALLATION	6
PREPARING THE HOUSING UNIT	6
ELECTRICAL CONNECTION.....	6
GENERAL RECOMMENDATIONS	6
THE APPLIANCE	7
ACCESSORIES	7
INSERTING WIRE SHELVES AND OTHER ACCESSORIES INTO THE OVEN	8
REMOVING LATERAL GRIDS.....	8
MOUNTING THE SLIDING SHELVES.....	8
CONTROL PANEL DESCRIPTION	9
KNOB AND TOUCH KEYS	9
LEFT DISPLAY	9
RIGHT DISPLAY	9
SETTING THE CLOCK.....	10
SETTINGS	10
ON/OFF	10
SELECTING A FUNCTION	10
QUICK START	11
SETTING THE TEMPERATURE.....	11
SETTING THE GRILL LEVEL.....	11
PREHEAT PHASE	11
SETTING DURATION	12
UNTIMED COOKING CYCLE.....	12
TIMED COOKING CYCLE	12
SETTING CYCLE END TIME WITH DELAYED START.....	12
6 TH SENSE FUNCTIONS.....	13
SPECIAL FUNCTIONS.....	13
FAST PREHEATING	13
AUTOMATIC OVEN CLEANING.....	14
PYRO CLEANING CYCLE	14
SMARTCLEAN™ CLEANING CYCLE	14
MEAT PROBE	15
CAVITY LIGHT	16
KEY-LOCK.....	16
FUNCTION DESCRIPTIONS TABLE	17
COOKING TABLE	19
TESTED RECIPES	22
RECOMMENDED USE AND TIPS	23
CLEANING	24
MAINTENANCE	25
REMOVING THE DOOR.....	25
MOVING THE TOP HEATING ELEMENT.....	25
REPLACING THE OVEN LAMP	25
TROUBLESHOOTING GUIDE	26
AFTER SALES SERVICES	26
SCRAPPING OF HOUSEHOLD APPLIANCES	26

IMPORTANT SAFETY INSTRUCTIONS

These instructions are also available on the website: www.whirlpool.eu

YOUR SAFETY AND THAT OF OTHERS IS VERY IMPORTANT

This manual and the appliance itself provide important safety warnings, to be read and observed at all times.



This is the danger symbol, pertaining to safety, which alerts users to potential risks to themselves and others. All safety warnings are preceded by the danger symbol and the following terms:

**DANGER**

Indicates a hazardous situation which, if not avoided, will cause serious injury.

**WARNING**

Indicates a hazardous situation which, if not avoided, could cause serious injury.

All safety warnings give specific details of the potential risk present and indicate how to reduce risk of injury, damage and electric shock resulting from improper use of the appliance. Carefully observe the following instructions:

- Keep these instructions close at hand for future reference.
- Use protective gloves to perform all unpacking and installation operations.
- The appliance must be handled and installed by two or more persons.
- The appliance must be disconnected from the power supply before carrying out any installation work.
- Installation and maintenance must be carried out by a qualified technician, in compliance with the manufacturer's instructions and local safety regulations. Do not repair or replace any part of the appliance unless specifically stated in the user manual.
- Power cable replacement must be carried out by a qualified electrician. Contact an authorised service centre.
- Regulations require that the appliance is earthed.
- Once the appliance is fitted in its housing, the power cable must be long enough to connect the appliance to the main power supply.
- For installation to comply with current safety regulations, an omnipolar switch with minimum contact gap of 3 mm must be used.
- Do not use extension leads, multiple socket adapters.
- Do not connect the appliance to a socket which can be operated by remote control or timer.

- Do not pull the power supply cable.
- The electrical components must not be accessible to the user after installation.
- If the surface of the induction plate is cracked, do not use it and switch off the appliance to avoid the possibility of electric shock (only for models with induction function).
- Do not touch the appliance with any wet part of the body and do not operate it when barefoot.
- This appliance is designed solely for use as a domestic appliance for cooking food. No other type of use is permitted (e.g.: heating rooms). The Manufacturer declines any liability for injury to persons or animals or damage to property if these advices and precautions are not respected.
- The appliance and its accessible parts become hot during use. Care should be taken to avoid touching heating elements.
- Very young (0-3 years) and young children (3-8 years) shall be kept away unless continuously supervised.
- Children of 8 years and above and persons with reduced physical, sensory or mental capabilities or lack of experience and knowledge, can use this appliance only if they are supervised or have been given instructions on safe appliance use and understand the hazards involved. Children must not play with the appliance. Cleaning and user maintenance must not be performed by children without supervision.
- During and after use, do not touch the heating elements or interior surfaces of the appliance – risk of burns. Do not allow the appliance to come into contact with cloths or other flammable materials until all the components have cooled down completely.
- At the end of cooking, exercise caution when opening the appliance door, letting the hot air or steam exit gradually before accessing the oven. When the appliance door is shut, hot air is vented from the aperture above the control panel. Do not obstruct the vent apertures.
- Use oven gloves to remove pans and accessories, taking care not to touch the heating elements.
- Do not place flammable materials in or near the appliance: a fire may break out if the appliance is inadvertently switched on.
- Do not heat or cook sealed jars or containers in the appliance. The pressure that builds up inside might cause the jar to explode, damaging the appliance.

- Do not use containers made of synthetic materials.
- Overheated oils and fats catch fire easily. Always remain vigilant when cooking foods rich in fat and oil.
- Never leave the appliance unattended during food drying.
- If alcoholic beverages are used when cooking foods (e.g. rum, cognac, wine), remember that alcohol evaporates at high temperatures. As a result, there is a risk that vapours released by the alcohol may catch fire upon coming into contact with the electrical heating element.
- Overheated oils and fats catch fire easily. Always remain vigilant when cooking foods rich in fat, oil or alcohol (e.g. rum, cognac, wine).
- Never use steam cleaning equipment.
- Do not touch the oven during the pyrolysis cycle. Keep children away from the oven during the pyrolysis cycle. Any excess spillage must be removed from the oven cavity before the cleaning cycle (only for ovens with Pyrolysis function).
- During and after the pyrolysis cycle, the animals have to be kept away from the area of the appliance location (only for ovens with Pyrolysis function).
- Use only the temperature probe recommended for this oven.
- Do not use harsh abrasive cleaners or sharp metal scrapers to clean the oven door glass as they can scratch the surface, which may result in the glass shattering.
- Ensure that the appliance is switched off before replacing the lamp to avoid the possibility of electric shock.
- Do not use aluminium foil to cover food in the cooking vessel (only for ovens with a cooking vessel supplied).

DECLARATION OF CONFORMITY 

This oven, which is intended to come into contact with foodstuffs, complies with European Regulation (CE) n. 1935/2004 and has been designed, manufactured and sold in conformity with the safety requirements of the "Low Voltage" directive 2006/95/CE (which replaces 73/23/CEE and subsequent amendments), the protection requirements of "EMC" 2004/108/CE.

This appliance meets the eco design requirements of European regulations n. 65/2014 and n. 66/2014 in conformity to the European standard EN 60350-1.

SAFEGUARDING THE ENVIRONMENT**Disposal of packaging materials**

The packaging material is 100% recyclable and is marked with the recycle symbol () . The various parts of the packaging must therefore be disposed of responsibly and in full compliance with local authority regulations governing waste disposal.

Energy saving tips

- Only preheat the oven if specified in the cooking table or your recipe.
- Use dark-lacquered or enamelled baking moulds as they absorb heat far better.
- Switch the oven off 10/15 minutes before the end of the set cooking time. Food requiring prolonged cooking will continue to cook even once the oven is switched off.

Scrapping the product

- This appliance is marked in conformity with European Directive 2012/19/EU, Waste Electrical and Electronic Equipment (WEEE).
- By ensuring this product is disposed of correctly, you will help prevent potential negative consequences for the environment and human health, which could otherwise be caused by inappropriate waste handling of this product.
- The symbol  on the product or on the accompanying documentation indicates that it should not be treated as domestic waste but must be taken to an appropriate collection centre for the recycling of electrical and electronic equipment.

INSTALLATION

After unpacking the oven, make sure that it has not been damaged during transport and that the oven door closes properly.

In the event of problems, contact the dealer or your nearest After-sales Service. To prevent any damage, only remove the oven from its polystyrene foam base at the time of installation.

Read all the safety recommendations at pages 2, 3, 4 before installing the appliance.

Follow the mounting instructions at page I, II, III and IV when installing the appliance.

PREPARING THE HOUSING UNIT

- Kitchen units in contact with the oven must be heat resistant (min 90°C).
- Carry out all cabinet cutting work and carefully remove all wood chips and sawdust before fitting the oven in the housing.
- After installation, the bottom of the oven must no longer be accessible.
- For correct appliance operation, do not obstruct the minimum gap between the worktop and the upper edge of the oven.

ELECTRICAL CONNECTION

Make sure the power voltage specified on the appliance data plate is the same as the mains voltage. The data plate is on the front edge of the oven (visible when the door is open).

- Power cable replacement (type H05 RR-F 3 x 1.5 mm²) must be carried out by a qualified electrician.

Contact an authorised service centre.

The oven is programmed to operate with power absorption above 2.5 kW (indicated by "16 A" in the settings, as shown on page 10) which is compatible with a domestic power supply above 3 kW.

If the household has a lower power supply, the setting must be lowered ("13 A" in the settings).

GENERAL RECOMMENDATIONS

Before use:

- Remove cardboard protection pieces, protective film and adhesive labels from accessories.
- Remove the accessories from the oven and heat it at 200° C for about an hour to eliminate the smell and fumes from the insulating materials and protective grease.

During use:

- Do not place heavy objects on the door as they could damage it.
- Do not cling to the door or hang anything from the handle.
- Do not cover the inside of the oven with aluminium foil.
- Never pour water into the inside of a hot oven; this could damage the enamel coating.
- Never drag pots or pans across the bottom of the oven as this could damage the enamel coating.
- Make sure that the electrical cables of other appliances do not touch hot parts of the oven or become trapped in the door.
- Do not expose the oven to atmospheric agents.

THE APPLIANCE

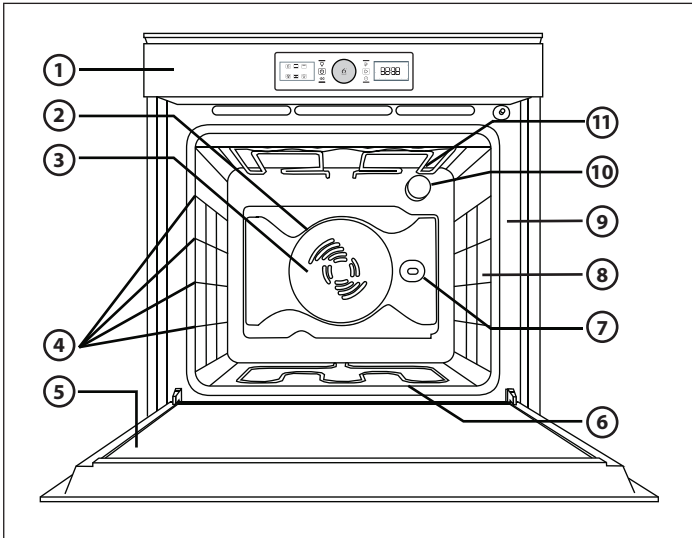

1. Control panel
2. Fan
3. Circular heating element (*not visible*)
4. Lateral grids (*the number of shelves is indicated on the front of the cavity*)
5. Door
6. Lower heating element (*not visible*)
7. Turnspit (*if present*)
8. Meat probe insert point (*if present*)
9. Data plate (*not to be removed*)
10. Light
11. Upper heating element / grill

NOTE:

- During cooking, the cooling fan may switch on at intervals in order to minimise energy consumption.
- At the end of cooking, after the oven has been switched off, the cooling fan may continue to run for a while.
- When the oven door is opened during cooking, the heating elements switch off.

ACCESSORIES

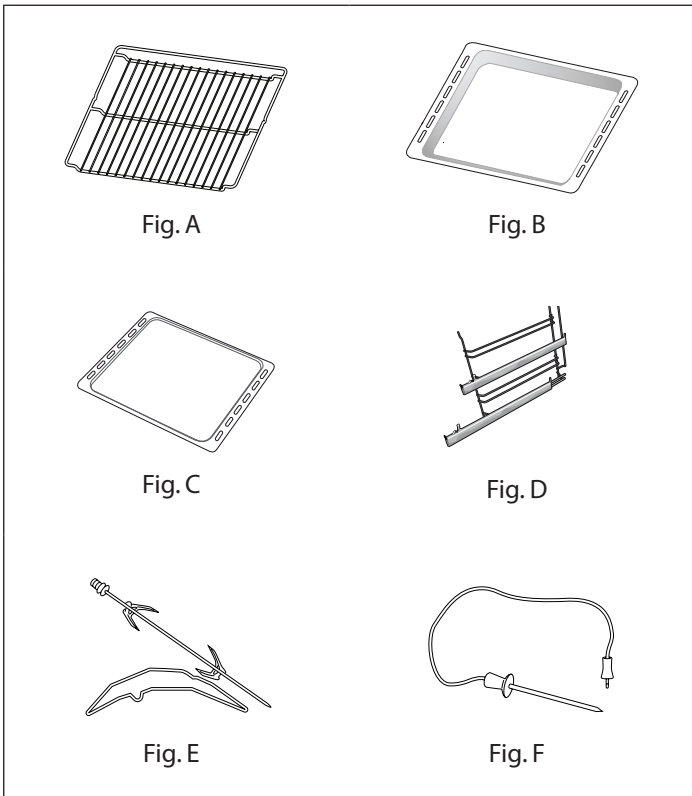

- A. Wire shelf:**
 - grilling
 - supporting pans, cakes, etc.
- B. Drip tray:**
 - collecting dripping fat
 - cooking meat, fish, etc.
- C. Baking tray:**
 - bread and pastry
 - meat, fish, etc.
- D. Sliding shelves (only in some models):**
 - for easier handling of shelves and trays.
- E. Turnspit (only in some models):**
 - for even roasting of large pieces of meat and poultry.
- F. Meat probe (only in some models):**
 - for measure the core temperature of food.

The number of accessories may vary according to the model purchased.

ACCESSORIES NOT SUPPLIED

Other accessories can be purchased separately from the After-sales Service.

INSERTING WIRE SHELVES AND OTHER ACCESSORIES INTO THE OVEN

1. Insert the wire shelf horizontally, with the raised part "A" upwards (Fig. 1).
2. Other accessories, such as the drip tray and baking tray, are inserted in the same way as the wire shelf (Fig. 2).

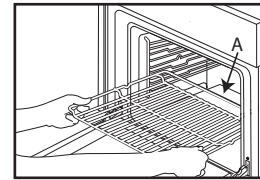

Fig. 1

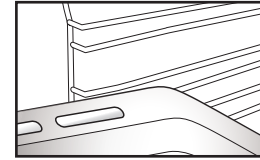

Fig. 2

REMOVING LATERAL GRIDS

Before running an automatic oven cleaning (see section 11), remove all the accessories from the cavity.

See pictures (Fig. 1, 2, 3) to remove lateral supports and (if present) cavity nuts that retain the same.

NOTE: *not following these instructions will result in a permanent damage to the accessories.*

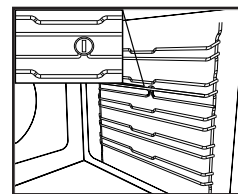

Fig. 1

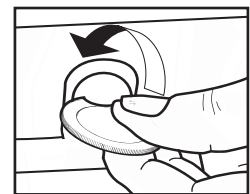

Fig. 2

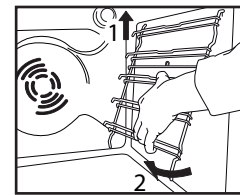

Fig. 3

MOUNTING THE SLIDING SHELVES (IF PRESENT)

Partial and full extension sliding shelves facilitate the handling of wire shelves and trays.

1. Remove the side holder grills (Fig. 1) (with full extension sliders, it is necessary to first remove the fixing screw).
2. Remove the plastic protection from the sliding shelves (Fig. 2).
3. Hang the upper part of the sliders on to the holder grills. Make sure the telescopic runners can move freely to the front of the oven. Then press the lower part of the sliding shelves firmly against the holder grill until they click into place (Fig. 3).
4. Refit the side holder grills to the cavity (Fig. 4).
5. Put the accessories on the slider (Fig. 5, 6).

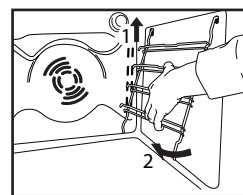

Fig. 1

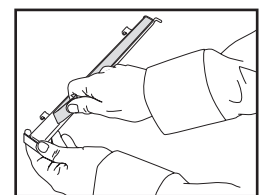

Fig. 2

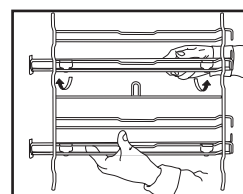

Fig. 3

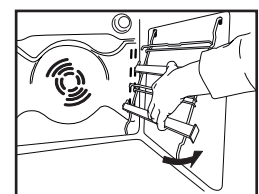

Fig. 4

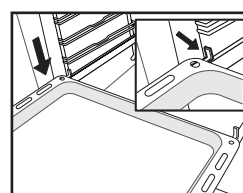

Fig. 5

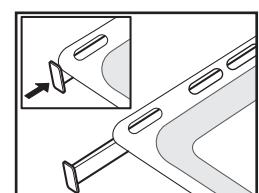
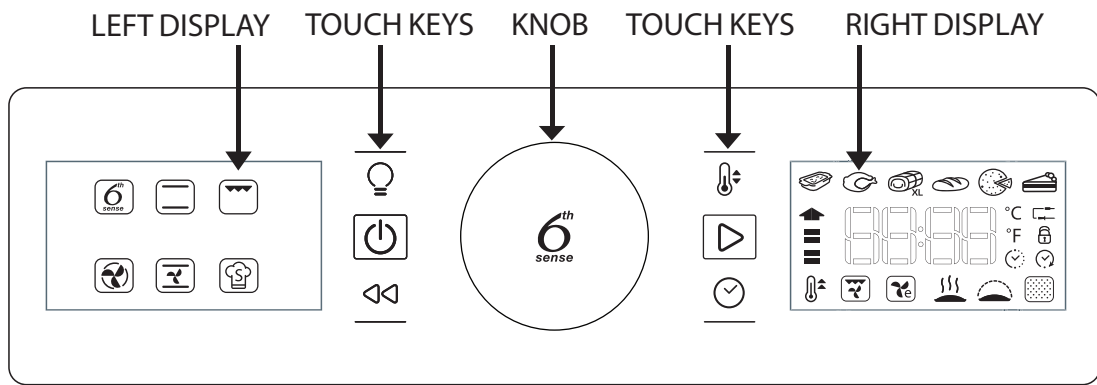
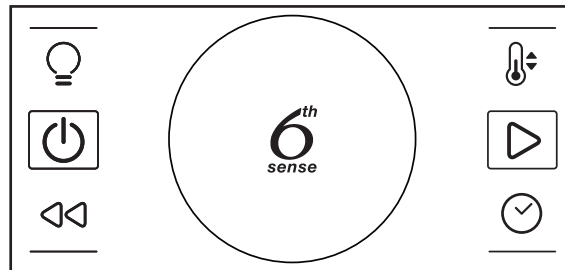

Fig. 6

CONTROL PANEL DESCRIPTION



KNOB AND TOUCH KEYS



ROTARY SWITCH KNOB
Turn this to navigate through the functions and adjust all of the cooking parameters.



6TH SENSE BUTTON KNOB
Press to select, set, access or confirm functions or parameters and eventually start the cooking program.



LIGHT
to switch the lamp on/off.



TEMP
to set the temperature.



ON/OFF
to switch the oven on/off.



START
to run cooking functions.



BACK
to return to the previous screen.



TIME
to set the clock, cooking duration or extend the cooking cycle time.

LEFT DISPLAY

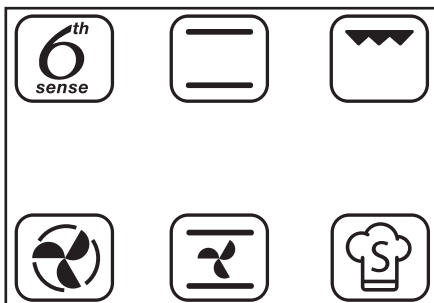

This display shows the main cooking functions. The selectable function is displayed more brightly. Symbols indicate the function. For a full description see the table on page 17.

RIGHT DISPLAY

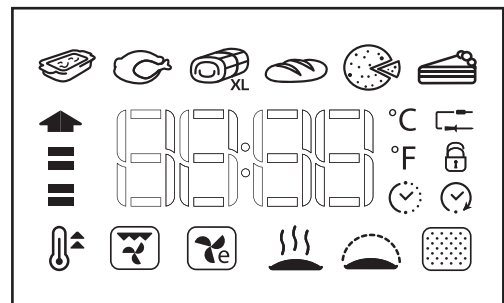

This display shows the clock, the clusters for 6th Sense (6th sense icon) and Special functions (Special icon), the details of all functions and helps to adjust all cooking parameters.

NOTE: the image shown may vary by the model purchased.

If the last right icon of the Special functions cluster does not light up, an Automatic cleaning function is not provided.

1.1 SETTING THE CLOCK

When the oven is switched ON for the first time, the clock must be set.

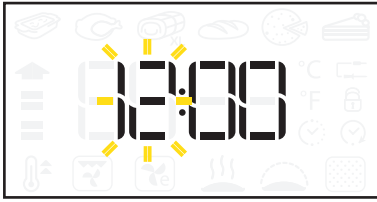

Turn  to set hours.

Press  to confirm.



Turn  to set minutes.

Press  to confirm.

NOTE: to change the time afterwards when the oven is switched OFF, hold  for at least 1 second and repeat the operations above. After a power failure the clock needs to be re-set.

1.3 ON/OFF

When the appliance is turned off only the 24 hour clock is displayed.



Press  to switch the oven ON (hold for ½ sec).

When the oven is switched ON, both displays are active.

The knob and all touch keys are fully functional.



NOTE: press  to always ends an active cooking cycle, turning OFF the appliance.

1.2 SETTINGS

If necessary the temperature units and electrical power settings can be changed from the default values (°C and 16A).

Hold for at least 5 seconds  when the oven is switched OFF (see section 1.3).



Turn  to select °C or °F.

Press  to confirm value.



Turn  to select power (16A or 13A).

Press  to confirm value.

NOTE: after confirming settings, it may be necessary to re-set the clock.

2 SELECTING A FUNCTION



To choose cooking cycles and further functions. For descriptions, see the table on page 17 and page 18.

Press  to switch the oven ON.

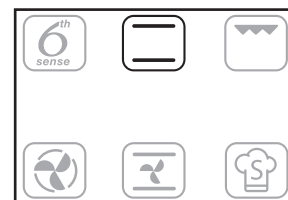
Turn  to select the main function: the selectable function is displayed more brightly.



Press  to confirm selection.

NOTE: select the 6th Sense  or Special functions  to access the related cluster in the righthand display (see the relevant section (7, 8) on page 13).

Proceed as indicated in the "quick start" section (section 3), to run the cooking function immediately or to go through the mode-setting wizard as indicated in sections 4, 5, and 6.

3 QUICK START





To skip the mode-setting wizard and to quickly launch a cooking cycle.

Press  to rapidly start any function.

The oven will run an untimed cooking cycle (see section 5.1) using the default temperature, and the display will count upwards to indicate time progress.

Press  to immediately start the cooking cycle using the most recent values set.

4 SETTING THE TEMPERATURE

To adjust the temperature for all cooking cycles provided, except Grill , Turbo Grill , Keep Warm  and Rising .



Press  to confirm desired function.

°C/°F icon flashes.



Turn  to set desired temperature.



Press  to confirm and go to set duration (see section 5) or press  to Quick start.

NOTE: turn  to adjust the temperature during a cooking cycle.

4.1 SETTING THE GRILL LEVEL



To set the power level for Grill  and Turbo Grill  cooking functions.

There are 3 defined power levels for grilling: -1- (low), -2- (mid), -3- (high).

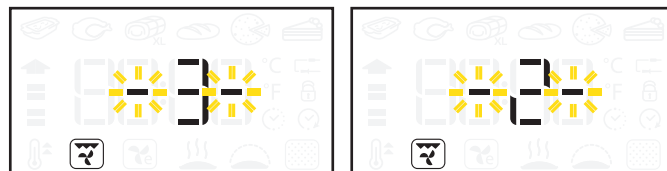
The right display shows the default value between two flashing "--".







Turn  to set desired level.

Press  to confirm and go to set duration (section 5) or press  to Quick start.

NOTE: turn  to adjust the grill level during a cooking cycle.

4.2 PREHEAT PHASE

For some functions (Conventional , Forced Air , Convection Bake , Fast Preheating ) there is preheat phase which starts automatically and enables the desired temperature to be reached quickly.



An arrow flashing in loop beside the target temperature indicates the preheat phase.

When the oven reaches the target temperature, a buzzer sounds.

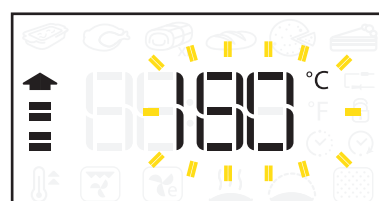

Put the food in the cavity and close the door: the oven automatically starts the chosen cooking cycle.



NOTE: Putting food into the cavity before the end of the preheat phase may compromise the cooking performance.

5 SETTING DURATION

To set the duration of a function after setting the temperature.

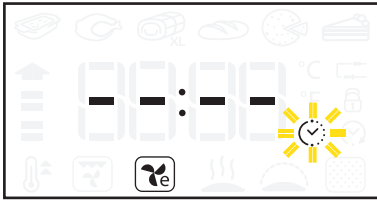

 Icon flashes.

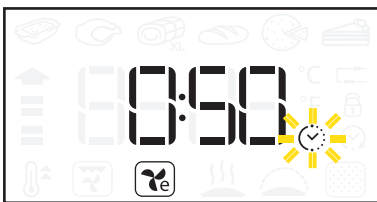

Press  or  to run an *untimed* cooking cycle (5.1).

Turn   to set duration.





Press  to confirm timed cooking time (5.2) and go to setting the end time or press  to Quick start.

NOTE: press  to adjust the duration during a cooking cycle.

5.1 UNTIMED COOKING CYCLE

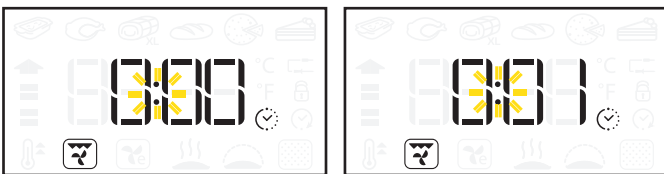
During an untimed cooking cycle the right display shows the duration counting up minute by minute and ":" flashes.



Press  to end the cooking cycle at any time and switch the oven OFF.

NOTE: press  to switch from untimed to timed cycle and set an end time.

5.2 TIMED COOKING CYCLE

During a timed cooking cycle, the right display shows the duration counting down minute by minute and ":" flashes.



Press  to end the cooking cycle at any time.

Once the cooking time has elapsed, the right display shows "End" and a buzzer sounds.



NOTE: the duration does not include the time for the preheat phase.

6 SETTING CYCLE END TIME WITH DELAYED START

To set the desired end time of a function.

The right display shows the time of cooking cycle end and the  icon flashes.



Turn   to set desired end time.

Press  to confirm end time.



NOTE: the time indicated on the display includes the duration set. During delay it is always possible to:

Turn   to extend the end time.

Press  to adjust the temperature level.

Press  to adjust the duration.

If the function provides a pre-heat phase, it will be skipped when a delay time has been set.

7 6TH SENSE FUNCTIONS

To choose between 6 different specific cooking cycles with pre-set values. For the full list and description of functions, see the table on page 17.

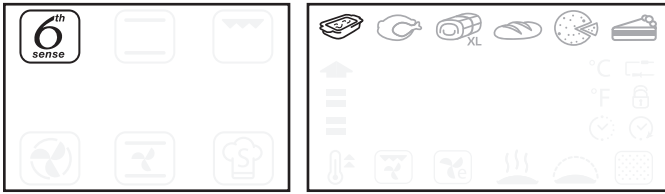

Turn  to select the 6th Sense function.



Press  to confirm.

Turn  to choose the desired 6th Sense function.



Press  to confirm and go to set duration/end time values or press  to Quick start.

NOTE: preheating the oven is not needed for all the 6th Sense functions. See the table on page 19 for the suggested cooking temperatures and durations.

6TH SENSE TEMPERATURE RECOVERY

If, during a 6th Sense cooking cycle, the temperature inside the cavity drops because the door has been opened, the 6th Sense temperature recovery function will automatically restore the original temperature.

During the 6th Sense temperature recovery, the display shows a "snake animation" until the target temperature has been reached.

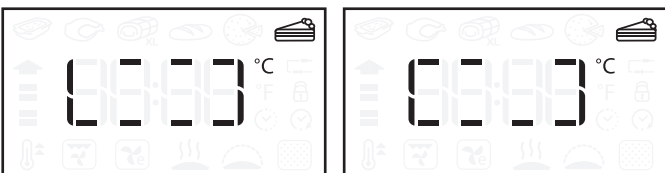

NOTE: during a timed cycle, in order to guarantee cooking performance, the duration will be increased by the amount of time the door has been open.

8 SPECIAL FUNCTIONS

To choose between different specific cooking cycles. For the full list and description of functions, see the table on page 18.

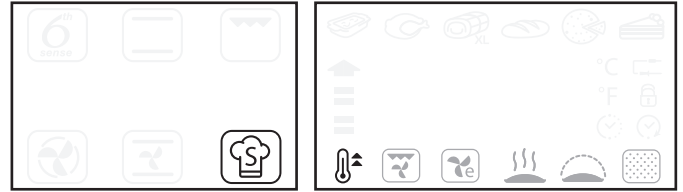

Turn  to select the special function.



Press  to confirm.

Turn  to choose the desired special function.





Press  to confirm and set values or press  to Quick start.

8.1 FAST PREHEATING



To preheat the oven quickly. See full description on page 18.

Access special functions .

Turn  to select .

Press  to confirm.

Turn  to select the desired temperature.

Press  to run fast preheating cycle or press  to set the duration of following cooking cycle.



When the oven reaches the target temperature, a buzzer sounds.

Put the food in the cavity and close the door: the oven automatically starts a cooking cycle keeping the temperature reached.

Do not put food into the cavity before the end of the fast-preheating cycle.

9 AUTOMATIC OVEN CLEANING (ONLY IN SOME MODELS)

The automatic cleaning function, where present, may vary according to which model is purchased.

PYRO CLEANING CYCLE (IF PRESENT)

For the description of this function, see also the functions table on page 18 and the chapter "Cleaning" on page 24.

Access special functions .



Turn  to select .



Press  to confirm.

Turn  to select desired pre-set duration.



Press  to run Pyro cleaning cycle or press  to go to set end time (section 6).

Turn  to set the desired end time.

Press  to start automatic oven cleaning.

NOTE: during a Pyro-cleaning cycle, the oven door is automatically locked.



Once the icon  disappears, the oven is once again fully functional.

WARNING



- Do not touch the oven during the pyrolysis cycle.
- Keep children away from the oven during the pyrolysis cycle.
- Keep animals away during and after the pyrolysis cycle.

SMARTCLEAN™ CLEANING CYCLE (IF PRESENT)

For the description of this function see also the functions table on page 18.



With the oven cold, distribute 200 ml of water on the bottom of the oven cavity, then close the oven door.

Access special functions .

Turn  to select .

Press  to confirm.



Press  to start immediately SMARTCLEAN™ cycle or press  to set end time/start delayed (see section 6).







At the end of the cycle, remove any residual water in the oven and start cleaning using a sponge moistened with hot water (cleaning could be compromised if delayed by more than 15 minutes).

To eliminate particularly stubborn grime, repeat the SMARTCLEAN™ cycle and add a few drops of neutral detergent while removing the grime.

NOTE: a smaller or greater amount of water could compromise proper functioning of the cleaning cycle. The duration of cleaning cycle cannot be set.

MEAT PROBE (ONLY IN SOME MODELS)

The meat probe supplied allows to measure the exact internal temperature of food during cooking.

The meat probe is allowed only in some cooking function (Conventional , Forced Air , Convection Bake , Turbo Grill , 6th Sense Meat ) and 6th Sense Maxicooking .

It is very important to position the probe accurately in order to obtain perfect cooking results. Insert the probe fully into the fleshiest part of the meat, avoiding bones and fatty parts (Fig. 1).

For poultry, the probe should be inserted sideways, in the middle of the breast, taking care to ensure the tip does not end up in a hollow part (Fig. 2).

In the case of meat with very irregular thickness, check it is cooked properly before removing it from the oven. Connect the end of the probe in the hole located on the right wall of the oven cavity.

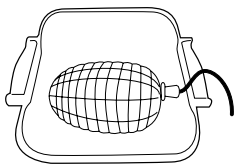

Fig. 1

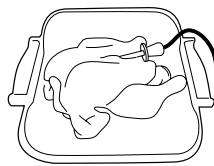



Fig. 2

IMPORTANT: pay attention to the cavity walls and to the food while inserting meat probe: these may be hot.

When the meat probe is plugged to the oven cavity, a buzzer sounds and the display shows icon  and target temperature.



If the meat probe is plugged during the selection of a function, display switches to the default meat probe target temperature.



Press  to start settings.

Turn  to set the meat probe target temperature.



Press  to confirm.

Turn  to set oven cavity temperature.



Press  or  to confirm and start the cooking cycle.

During cooking cycle, the display shows meat probe target temperature.

When the meat reaches the target temperature set, the cooking cycle stops and the display shows "End".



To restart the cooking cycle From "End", by turning  it is possible to adjust meat probe target temperature as indicated above.

Press  or  to confirm and restart the cooking cycle.

NOTE: during cooking cycle with meat probe it is possible turn  to change meat probe target temperature.

Press  to adjust oven cavity temperature.

See the table at page 19 to know the ideal temperature for each kind of meat.

The meat probe can be inserted at any time, also during a cooking cycle. In this case, it is necessary re-set the cooking function parameters.

If meat probe is incompatible with a function, the oven switch off the cooking cycle and plays an alert buzzer sound. In this case, disconnect the meat probe or press  to set another function.

Start delayed and preheat phase are not compatible with meat probe.

10 CAVITY LIGHT

Press  to switch the cavity lamp ON or OFF.

During the Eco Forced Air  function the lamp will be switched off after 1 minute.

During the Pyro cycle  (if present) the cavity lamp cannot be switched on.

During a cooking cycle with meat probe (if present) it will be always switched on.

11 KEY-LOCK

To lock the control panel buttons.

Hold  for at least 5 seconds.



To deactivate.

Hold  for at least 5 seconds.





























For safety reasons, the oven can always be switched OFF during a cooking cycle by pressing the ON/OFF button.

FUNCTION DESCRIPTIONS TABLE

















Traditional function		CONVENTIONAL	To cook any kind of dish on one shelf only. Use the 3 rd shelf. To cook pizza, savoury pies and sweets with liquid fillings, use the 1 st or 2 nd shelf. Preheat the oven before placing food inside.	
		GRILL	To grill steak, kebabs and sausages; to cook vegetables au gratin and toast bread. Place food on the 4 th or 5 th shelf. When grilling meat, use the drip tray to collect the cooking juices. Position it on the 3 rd /4 th shelf, adding approx. half a litre of water. The oven does not have to be preheated. During cooking, the oven door must remain closed.	
		FORCED AIR	To cook a variety of food requiring the same temperature on several shelves (maximum three) at the same time (e.g. Fish, vegetables, cakes). This function can be used to cook different foods without odours being transferred from one food to another. Use the 3 rd shelf to cook on one shelf only, the 1 st and 4 th to cook on two shelves, and the 1 st , 3 rd and 5 th to cook on three shelves. Preheat the oven before cooking.	
		CONVECTION BAKE	For cooking meat, filled pies (cheesecake, strudel, fruit pies) and stuffed vegetables on one level only. This function uses discontinuous, delicate fan assistance, which prevents excessive drying of foods. Use the 2 nd shelf. Wait for the end of preheating before placing food inside.	
6th Sense functions			6th Sense CASSEROLE	The function automatically selects the best cooking mode and temperature for baking any dish prepared with pasta (lasagne, cannelloni, etc). The temperature may be modified within a given range to perfectly suit different recipes and personal tastes. Use the 2 nd shelf. The oven does not have to be preheated.
			6th Sense MEAT	The function automatically selects the best cooking mode and temperature for roasting any type of meat (poultry, beef, veal, pork, lamb, etc). The temperature may be modified within a given range to perfectly suit different recipes and personal tastes. This function uses discontinuous, delicate fan assistance, which prevents excessive drying of foods. Use the 2 nd shelf. The oven does not have to be preheated before cooking.
			6th Sense MAXI COOKING	The function automatically selects the best cooking mode and temperature to cook large joints of meat (above 2.5 kg). It is advisable to turn the meat over during cooking for more even browning. It is best to baste the meat every now and again to prevent it from drying out. Use the 1 st or 2 nd shelves, depending on the size of the joint. The oven does not have to be preheated before cooking.
			6th Sense BREAD	The function automatically selects the best cooking mode and temperature for baking any type of bread (baguettes, bread rolls, sandwich loaf, etc). The temperature may be modified within a given range to perfectly suit different recipes and personal tastes. Use the 2 nd shelf. The oven does not have to be preheated.
			6th Sense PIZZA	The function automatically selects the best cooking mode and temperature for baking any type of pizza (thin pizza, home-style pizza, focaccia, etc). The temperature may be modified within a given range to perfectly suit different recipes and personal tastes. Use the 2 nd shelf. The oven does not have to be preheated.
			6th Sense PASTRY	The function automatically selects the best cooking mode and temperature for baking any sweet preparation (biscuits, sponge cakes, fruit tarts, etc). The temperature may be modified within a given range to perfectly suit different recipes and personal tastes. Use the 2 nd or 3 rd shelf. The oven does not have to be preheated.









FUNCTION DESCRIPTIONS TABLE

Special functions			To preheat the oven rapidly. At the end of preheating, the oven automatically selects the conventional function. Wait for the end of preheating before placing food inside.
		FAST PREHEATING	
			To roast large joints of meat (legs, roast beef, chickens). Position the food on the middle shelves. Use the drip tray to collect the cooking juices. Position it on the 1 st /2 nd shelf, adding approx. half a litre of water. The oven does not have to be preheated. During cooking the oven door must remain closed. With this function you can also use the turnspit, if provided.
		TURBOGRILL	
			To cook stuffed roasts and pieces of meat on one shelf. This function uses discontinuous, delicate fan assistance, which prevents excessive drying of foods. In this ECO function the light remains off during cooking and can be temporarily switched on again by pressing the confirm button. In order to maximise energy efficiency, it is advisable not to open the door during cooking. It is advisable to use the 3 rd level. The oven does not have to be preheated.
		ECO FORCED AIR	
			For keeping just-cooked food hot and crisp (e.g: meat, fried food or flans). Place food on the middle shelf.
KEEP WARM			
	For optimal rising of sweet or savory dough. Place the dough on the 2 nd shelf. The oven does not have to be preheated. To safeguard the quality of proving, do not activate the function if the oven is still hot after a cooking cycle.		
RISING			
	To burn off spatters produced during cooking with an extremely high temperature cycle (approx. 500°C). Two auto-cleaning cycles are available: a complete cycle (PYRO) and a shorter cycle (ECO). The complete cycle is best used only in cases of very dirty ovens, while the shorter cycle should be used more regularly.		
PYRO AUTOMATIC OVEN CLEANING (if present)			
	To eliminate the dirt created by cooking by means of a low temperature cycle. The combined action of the special enamel and the water vapour released during the cycle facilitates removal of grime. Place 200 ml of water in the bottom of the cavity and activate the function when the oven is cold.		
SMARTCLEAN™ OVEN CLEANING (if present)			

COOKING TABLE						
Recipe	Function	Preheating	Shelf (from bottom)	Temp. (°C)	Time (min)	Accessories and notes
Sponge cakes		-	2/3	160 - 180	30 - 90	Cake tin on wire shelf
		Yes	1 - 4	160 - 180	30 - 90	Shelf 4: Cake tin on wire shelf Shelf 1: Cake tin on wire shelf
Filled pies (cheesecake, strudel, apple pie)		-	3	160 - 200	30 - 85	Drip tray/baking tray or cake tin on wire shelf
		Yes	1 - 4	160 - 200	35 - 90	Shelf 4: Cake tin on wire shelf Shelf 1: Cake tin on wire shelf
Biscuits/ Tartlets		-	3	170 - 180	15 - 45	Drip tray/baking tray
		Yes	1 - 4	160 - 170	20 - 45	Shelf 4: Wire shelf Shelf 1: Drip tray/baking tray
Choux buns		-	3	180 - 200	30 - 40	Drip tray/baking tray
		Yes	1 - 4	180 - 190	35 - 45	Shelf 4: Oven tray on wire shelf Shelf 1: Drip tray/baking tray
Meringues		Yes	3	90	110 - 150	Drip tray/baking tray
		Yes	1 - 4	90	130 - 150	Shelf 4: Oven tray on wire shelf Shelf 1: Drip tray/baking tray
Pizza (deep pan pizza, thin pizza, focaccia)		-	2	220 - 250	20 - 40	Drip tray/baking tray
		Yes	1 - 4	220 - 240	20 - 40	Shelf 4: Baking tray or oven tray on wire shelf Shelf 1: Drip tray/baking tray
Bread (sandwich loaf) 0.5/1kg		-	2	180 - 220	50 - 70	Drip tray/baking tray
Bread (small breads)		-	2	180 - 220	30 - 50	Drip tray/baking tray
Bread		Yes	1 - 4	180 - 200	30 - 60	Shelf 4: Oven tray on wire shelf Shelf 1: Drip tray/baking tray
Frozen pizza		Yes	3	250	10 - 15	Drip tray/baking tray or wire shelf
		Yes	1 - 4	250	10 - 20	Shelf 4: Oven tray on wire shelf Shelf 1: Drip tray/baking tray
Savoury pies (vegetable pie, quiche lorraine)		Yes	2	180 - 190	45 - 60	Cake tin on wire shelf
		Yes	1 - 4	180 - 190	45 - 60	Shelf 4: Cake tin on wire shelf Shelf 1: Cake tin on wire shelf

COOKING TABLE















Vol-au-vents/ puff pastry savouries		Yes	3	190 - 200	20 - 30	Drip tray/baking tray
		Yes	1 - 4	180 - 190	20 - 40	Shelf 4: Oven tray on wire shelf Shelf 1: Drip tray/baking tray
Lasagna / Flans / Baked pasta / Cannelloni		Yes	3	190 - 200	40 - 65	Drip tray or oven tray on wire shelf
Lasagne/ Flans		-	3	190 - 200	40 - 65	Drip tray or oven tray on wire shelf
Baked pasta/ Cannelloni		-	3	190 - 200	25 - 45	Drip tray or oven tray on wire shelf
Lamb/Veal/ Beef/Pork 1kg		-	3	190 - 200	60 - 90	Drip tray or oven tray on wire shelf
Leg of lamb/ Shanks		-	3	2 (mid)	60 - 90	Drip tray or oven tray on wire shelf (turn food two thirds of the way through cooking if necessary)
Chicken/ Rabbit/Duck 1 kg		-	3	220 - 230	50 - 80	Drip tray or oven tray on wire shelf (turn food two thirds of the way through cooking if necessary)
Turkey/Goose 3 kg		-	2	190 - 200	90 - 150	Drip tray or oven tray on wire shelf
Pork Roast with rind 2 kg		-	2	170	110 - 150	Drip tray or oven tray on wire shelf
Baked fish/en papillote (fillet, whole)		Yes	3	180 - 200	40 - 60	Drip tray or oven tray on wire shelf
Stuffed vegetables (tomatoes, courgettes, aubergines)		Yes	2	180 - 200	50 - 60	Oven tray on wire shelf
Toast		-	5	3 (High)	3 - 6	Wire shelf
Fish fillets/ steaks		-	4	2 (Mid)	20 - 30	Shelf 4: Wire shelf (turn food halfway through cooking)
						Shelf 3: Drip tray with water
Sausages/ Kebabs/ Spare ribs/ Hamburgers		-	5	2-3 (Mid - High)	15 - 30	Shelf 5: Wire shelf (turn food halfway through cooking)
						Shelf 4: Drip tray with water
Roast chicken 1-1.3 kg		-	2	2 (Mid)	55 - 70	Shelf 2: Wire shelf (turn food two thirds of the way through cooking)
						Shelf 1: Drip tray with water

COOKING TABLE						
Roast chicken 1-1.3 kg		-	2	3 (High)	60 - 80	Shelf 2: Turnspit (if present)
						Shelf 1: Drip tray with water
Roast potatoes		-	3	2 (Mid)	35 - 55	Drip tray/baking tray (turn food two thirds of the way through cooking if necessary)
Vegetable gratin		-	3	3 (High)	10 - 25	Drip tray or oven tray on wire shelf
Lasagne & Meat		Yes	1 - 4	200	50 - 100*	Shelf 4: Oven tray on wire shelf
						Shelf 1: Drip tray or oven tray on wire shelf
Meat & Potatoes		Yes	1 - 4	200	45 - 100*	Shelf 4: Oven tray on wire shelf
						Shelf 1: Drip tray or oven tray on wire shelf
Fish & Vegetables		Yes	1 - 4	180	30 - 50*	Shelf 4: Oven tray on wire shelf
						Shelf 1: Drip tray or oven tray on wire shelf
Complete meal: Tart (Shelf 5) / Lasagna (Shelf 3) / Meat (Shelf 1)		-	1 - 3 - 5	190	40 - 120*	Shelf 5: Oven tray on wire shelf
						Shelf 3: Oven tray on wire shelf
						Shelf 1: Drip tray or oven tray on wire shelf
Filled roast meats		-	3	200	80 - 120*	Drip tray or oven tray on wire shelf
Meat cuts (rabbit, chicken, lamb)		-	3	200	50 - 100*	Drip tray or oven tray on wire shelf

* Cooking time is approximate. Food can be removed from the oven at different times depending on personal preference.

Meat probe* recipes	
Meat cuts	Final core temperature of meat (°C)
Roast beef rare	48
Roast beef medium	60
Roast beef well done	68
Roast turkey	75
Roast chicken	83
Roast pork	75
Roast veal	68



* Only in some models

TESTED RECIPES (IN COMPLIANCE WITH IEC 60350-1:2011-12)						
Recipe	Function	Preheating	Shelf (from bottom)	Temp. (°C)	Time (min)	Accessories* and notes
IEC 60350-1:2011-12 § 7.5.2						
Shortbread		-	3	150	35 - 50	Drip tray/baking tray
		Yes	3	150	25 - 40	Drip tray/baking tray
		Yes	1 - 4	150	25 - 35	Shelf 4: Baking tray Shelf 1: Drip tray/baking tray
IEC 60350-1:2011-12 § 7.5.3						
Small cakes		-	3	170	25 - 35	Drip tray/baking tray
		Yes	3	160	20 - 30	Drip tray/baking tray
		Yes	1 - 4	160	25 - 35	Shelf 4: Baking tray Shelf 1: Drip tray/baking tray
IEC 60350-1:2011-12 § 7.6.1						
Fatless sponge cake		-	2	170	30 - 40	Cake tin on wire shelf
		Yes	2	160	30 - 40	Cake tin on wire shelf
		Yes	1 - 4	160	35 - 45	Shelf 4: Cake tin on wire shelf Shelf 1: Cake tin on wire shelf
IEC 60350-1:2011-12 § 7.6.2						
2 Apple pie		-	2	185	70 - 90	Cake tin on wire shelf
		Yes	2	175	70 - 90	Cake tin on wire shelf
		Yes	1 - 4	175	75 - 95	Shelf 4: Cake tin on wire shelf Shelf 1: Cake tin on wire shelf
IEC 60350-1:2011-12 § 9.2						
Toast		-	4	3 (High)	3 - 6	Wire shelf
IEC 60350-1:2011-12 § 9.3						
Burgers		-	4	3 (High)	18 - 30	Shelf 5: Wire shelf (turn food halfway through cooking) Shelf 4: Drip tray with water

* When not provided, accessories can be purchased from after sale service.

** 6th Sense PASTRY  function uses upper and lower heating elements only, without forced air circulation.
It doesn't require preheating.

The indications in the table are without use of the sliding shelves. Do the tests without these.

Preheating the empty oven (according to IEC 60350-1:2011-12 § 7.2): test CONVENTIONAL , FORCED AIR , FAST PREHEAT  functions.

Energy efficiency class (according to EN 60350-1:2013-07): to do the test, use the dedicated table.

RECOMMENDED USE AND TIPS

How to read the cooking table

The table indicates the best function to use for any given food, to be cooked on one or more shelves at the same time. Cooking times start from the moment food is placed in the oven, excluding preheating (where required). Cooking temperatures and times are purely for guidance and will depend on the amount of food and type of accessory used. Use the lowest recommended values to begin with and, if the food is not cooked enough, move on to higher values. Use the accessories supplied and preferably dark-coloured metal cake tins and oven trays. You can also use pans and accessories in pyrex or stoneware, but bear in mind that cooking times will be slightly longer. To obtain the best results, carefully follow the advice given in the cooking table for the choice of accessories (supplied) to be placed on the various shelves.

Cooking different foods at the same time

Using the "FORCED AIR" function, you can cook different foods which require the same cooking temperature at the same time (for example fish or vegetables), using different shelves. Remove the food which requires less cooking time and leave food which requires longer cooking time in the oven.

Desserts

- Cook delicate desserts with the conventional function on one shelf only. Use dark-coloured metal cake tins and always position them on the wire shelf supplied. To cook on more than one shelf, select the forced air function and stagger the position of the cake tins on the shelves, aiding optimum circulation of the hot air.
- To check whether a cake is cooked, insert a wooden toothpick into the centre of the cake. If the toothpick comes out clean, the cake is ready.
- If using non-stick cake tins, do not butter the edges as the cake may not rise evenly around the edges.
- If the cake "sinks" during cooking, set a lower temperature the next time, perhaps reducing the amount of liquid in the mixture and mixing more gently.
- For desserts with moist fillings (cheesecake or fruit pies) use the "CONVECTION BAKE" function. If the pastry base is soggy, lower the shelf and sprinkle the bottom of the cake with biscuit crumbs before adding the filling.

Meat

- Use any kind of oven tray or pyrex dish suited to the size of the piece of meat being cooked. For roast joints, it is best to add some stock to the bottom of the pan, basting the meat during cooking for added flavour. When the roast is ready, let it rest in the oven for another 10-15 minutes, or wrap it in aluminium foil.
- If you want to grill meat, choose cuts with an even thickness all over in order to achieve uniform cooking results. Very thick pieces of meat require longer cooking times.

To prevent the meat from burning on the outside, lower the position of the wire shelf, keeping the food further away from the grill. Turn the meat two thirds of the way through cooking.

To collect the cooking juices it is advisable to place a drip-tray with half a litre of water directly under the grill on which the meat is placed. Top-up when necessary.

Turnspit (only in some models)

Use this accessory to evenly roast large pieces of meat and poultry. Place the meat on the spit rod, (for chicken, tying it with string) and check that it is secure before inserting the rod in the seat located on the front wall of the oven and resting it on the respective support.

To prevent smoke and to collect cooking juices, it is advisable to place a drip-tray with half a litre of water on the first level. The rod has a plastic handle which must be removed before starting to cook and used at the end of cooking to avoid burns when taking the food out of the oven.

Pizza

Lightly grease the trays to ensure the pizza has a crispy base. Scatter the mozzarella over the pizza two thirds of the way through cooking.

Dough proving function

It is always best to cover the dough with a damp cloth before placing it in the oven. Dough proving time with this function is reduced by approximately one third compared to proving at room temperature (20-25°C). Proving time for a 1 kg batch of pizza dough is around one hour.

CLEANING

WARNING

- **Never use steam cleaning equipment.**
- **Only clean the oven when it is cool to the touch.**
- **Disconnect the appliance from the power supply.**

Oven exterior

- Clean the surfaces with a damp microfibre cloth. If it is very dirty, add a few drops of washing up detergent to the water. Finish off with a dry cloth.

Do not use corrosive or abrasive detergents. If any of these products accidentally comes into contact with the appliance, clean immediately with a damp microfibre cloth.

Oven interior

- After every use, allow the oven to cool and then clean it, preferably while it is still warm in order to remove built-up dirt and stains caused by food residues (e.g. food with a high sugar content).
- Do not use corrosive or abrasive detergents.
- Clean the door glass with a suitable liquid detergent. The oven door can be removed to facilitate cleaning (see MAINTENANCE).
- The top heating element of the grill (see MAINTENANCE) can be lowered (some models only) to clean the roof of the oven.

NOTE: during prolonged cooking of foods with a high water content (e.g. pizza, vegetables, etc.) condensation may form on the inside of the door and around the seal. When the oven is cold, dry the inside of the door with a cloth or sponge.

Do not use abrasive sponges or metallic scrapers or scourers. Over time, these can ruin enamelled surfaces and the oven door glass.

Accessories

- Soak the accessories in water with washing up detergent immediately after use, handling them with oven gloves if still hot.
- Food residues can be easily removed using a brush or sponge.

Cleaning the rear wall and catalytic side panels of the oven (if present):

- Operate the oven empty with the fan-assisted function at 200°C for about one hour
- Next, leave the appliance to cool down before removing any food residue with a sponge.

Do not use corrosive or abrasive detergents, coarse brushes, pot scourers or oven sprays which could damage the catalytic surface and ruin its self-cleaning properties.

Cleaning cycle - Pyrolysis function

WARNING

- **Do not touch the oven during the pyrolysis cycle.**
- **Keep children away from the oven during the pyrolysis cycle.**
- **Keep animals away during and after the pyrolysis cycle.**

This function burns off spatters produced inside the oven during cooking at a temperature of approx. 500°C. At this high temperature, the deposits turn into a light ash which can be easily wiped away with a damp cloth, when the oven is cool. Do not select the pyrolysis function after every use, only when the oven is very dirty or produces smoke or fumes while preheating or cooking.

- If the oven is installed below a hob, make sure that all burners or electric hotplates are switched off during the self-cleaning (pyrolysis) function.
- Remove all accessories before running the pyrolysis function (also the lateral grids).
- For optimum cleaning of the oven door, remove the worst soiling with a damp sponge before using the pyrolytic function.

The appliance is equipped with 2 pyrolysis functions:

1. Energy-saving cycle (PYRO EXPRESS/ECO): which consumes approximately 25% less energy than the standard cycle. Select it at regular intervals (after cooking meat on 2 or 3 consecutive occasions).
2. Standard cycle (PYRO): which is suitable for cleaning a very dirty oven.

NOTE: during the pyrolysis function, the oven door will not open; it will remain locked until the temperature inside the oven has returned to an acceptably safe level.

MAINTENANCE

WARNING

- Use protective gloves.
- Ensure the oven is cold before carrying out the following operations.
- Disconnect the appliance from the power supply.

REMOVING THE DOOR

1. Open the door fully.
2. Lift the catches and push them forwards as far as they will go (Fig. 1).
3. Close the door as far as it will go (A), lift it up (B) and turn it (C) until it is released (D) (Fig. 2).

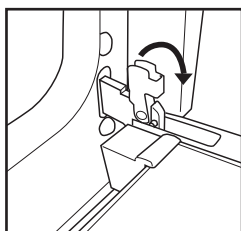

Fig. 1

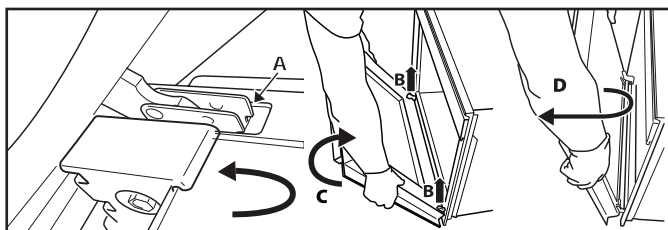

Fig. 2

To refit the door:

1. Insert the hinges in their seats.
2. Open the door fully.
3. Lower the two catches.
4. Close the door.

MOVING THE TOP HEATING ELEMENT (SOME MODELS ONLY)

1. Remove the side accessory holder grills.
2. Pull the heating element out a little (Fig. 3) and lower it (Fig. 4).
3. To reposition the heating element, lift it up, pulling it slightly towards you, making sure it comes to rest on the lateral support.

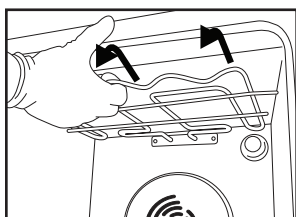

Fig. 3

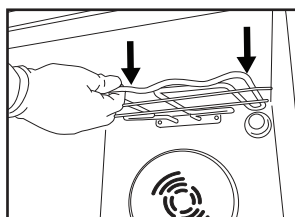

Fig. 4

REPLACING THE OVEN LAMP

To replace the rear lamp:

1. Disconnect the oven from the power supply.
2. Unscrew the lamp cover (Fig. 6), replace the lamp (see note for lamp type) and screw the lamp cover back on.
3. Reconnect the oven to the power supply.

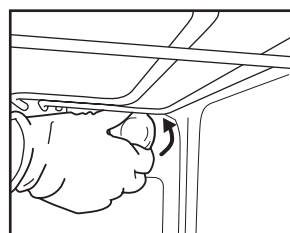

Fig. 6

NOTE:

- Only use 25-40W/230V type E-14, T300°C incandescent lamps, or 20-40W/230 V type G9, T300°C halogen lamps.
- The lamp used in the appliance is specifically designed for electrical appliances and is not suitable for household room illumination (Commission Regulation (EC) No 244/2009).
- Lamps are available from our After-sales Service.

IMPORTANT:

- If using halogen lamps, do not handle with bare hands as fingerprints can damage them.
- Do not use the oven until the lamp cover has been repositioned.

TROUBLESHOOTING GUIDE

The oven does not work

- Check for the presence of mains electrical power and that the oven is connected to the electrical supply.
- Turn off the oven and restart it to see if the fault persists.

The electronic programmer does not work

- If the display shows the letter "F" followed by a number, contact your nearest After-sales Service.

In this case, quote the number that follows the letter "F".

The door will not open

- Turn off the oven and restart it to see if the fault persists.

Important: during pyro self-cleaning (if present), the oven door will not open. Wait until it unlocks automatically (see paragraph "Cleaning cycle of ovens with pyrolysis function").

AFTER SALES SERVICES

Before calling the After-Sales Service

1. See if you can solve the problem yourself with the help of the suggestions given in the "Troubleshooting guide".
2. Switch the appliance off and back on again to see if the fault persists.

If the above checks have been carried out and the fault still occurs, get in touch with the nearest After-sales Service.

Always specify:

- a brief description of the fault;
- the type and exact model of the oven;

- the service number (number after the word Service on the rating plate), located on the right hand edge of the oven cavity (visible when the oven door is open). The service number is also indicated on the guarantee booklet;
- your full address;
- your telephone number.

NOTE: if any repairs are required, please contact an authorised After-sales Service (to guarantee that original spare parts will be used and repairs carried out correctly).

SERVICE 0000 000 00000



SCRAPPING OF HOUSEHOLD APPLIANCES

- This appliance is manufactured with recyclable or reusable materials. Scrap the appliance in accordance with local regulations on waste disposal. Before scrapping, cut off the power cords so that the appliances cannot be connected to the mains.
- For further information on the treatment, recovery and recycling of household electrical appliances, contact your competent local authority, the collection service for household waste or the store where you purchased the appliance.

IT ES PT GR FR EN



400010782404

Printed in Italy

Manufacturer: Whirlpool Europe S.r.l. Socio Unico, Viale G. Borghi 27, 21025 Comerio (VA) ITALY



Whirlpool is a registered trademark of Whirlpool, USA.