

**FTCL 87**

## TUMBLE DRYER



This symbol reminds you to read this booklet.

! Keep this instruction booklet on hand in order to refer to it when necessary. Take it with you when you move, and should you sell this appliance or pass it on to another party, make sure that this booklet is supplied along with the dryer so that the new owner may be informed about warnings and suggestions on how the appliance works.

! Read these instructions carefully; the following pages contain important information on installation and suggestions on how the appliance works.

## Contents

### Installation, 2-3

- Where to put your dryer
- Ventilation
- Water drain
- Levelling
- Electrical connection
- Before you start using your dryer

### Warnings, 4-5

- General safety
- To minimise the risk of fire

### Maintenance and Care, 6-7

- Switching off the electricity
- Cleaning the filter after each cycle
- Cleaning the heat pump filter unit
- Empty the water container after each cycle
- Check the drum after each cycle
- Cleaning the dryer

### Dryer description, 8

- The features
- Control panel

### Start and programmes, 9-13

- Choosing a programme
- Programmes Table
- The controls

### Laundry, 14

- Sorting your laundry
- Wash care labels
- Drying times

### Troubleshooting, 15

### Assistance and guarantee, 16

- Heat Pump system
- Spare parts
- Guarantee
- Save energy and respect the environment

### Product data, 17

- Recycling and Disposal

**To activate your free\* 10 Year Parts Guarantee  
Call free on 0800 597 8557**

\*Labour charges not included. Terms and conditions apply. Lines open 364 days a year. Calls are free from a BT landline. Charges from other providers and mobiles may apply.

# Installation

GB

## Where to put your dryer

- Place your dryer at a distance from gas ranges, stoves, heaters, or cook tops because flames can damage the appliance.
- The dryer should be installed in an ambient room temperature of between 20 to 23°C for optimum performance. But will function if the room is between 14 and 30°C.

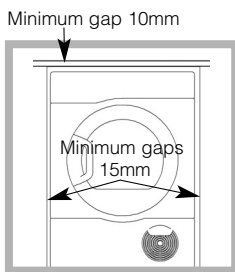

- If you are going to install the appliance under a work counter, be sure to leave a 10mm space between the top and any other objects on or above the machine and a 15mm space between

the sides and lateral furnishings or walls. This is to ensure proper air circulation. The appliance must be installed with the rear surface placed against a wall. **!** Make sure that the back vents are not obstructed.

## Ventilation

When the dryer is in use, there has to be adequate ventilation. Make sure you put your dryer in an environment that is not damp and has proper air circulation throughout. Airflow around the dryer is essential to condense the water produced during the washing, the dryer will not operate efficiently in an enclosed space or cupboard.

**!** If using the dryer in a small or cold room some condensation could be experienced.

**!** We do not recommend that the dryer is installed in a cupboard but the dryer must never be installed behind a lockable door, a sliding door or a door with a hinge on the opposite side to that of the dryer door.

## Water drain

If your dryer is installed next to a drain the water can be plumbed into this drain. This does away with the need to empty the water container. If the dryer is stacked onto or installed next to a washing machine it can share the same drain.

The height of the drain must be less than 3' (1m) from the bottom of the dryer.

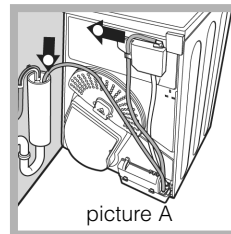

Remove the existing hose from position shown in picture A.

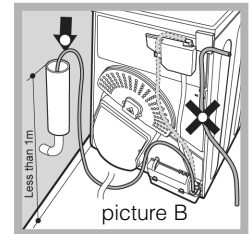

Then fit a suitable length of hose to position shown in picture B.

**!** Make sure that the hose is not squashed or kinked when the dryer is in its final location.

## Levelling your dryer

The dryer must be installed level for correct operation.

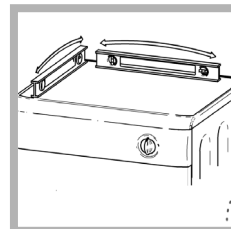

When you have installed your dryer in its final location check that it is level first side to side, then front to back.

If the dryer is not level, adjust the two front legs up or down, until your dryer is level.

**! WARNING: Before you use your dryer ensure that it has been in an upright position for at least 6 hours.**

## Electrical connections

Make sure of the following before you insert the plug into the the electrical socket:

- Make sure your hands are dry.
- The socket must have an earth connection.
- The socket must be able to sustain the machines maximum power, which is indicated on the rating label (*see Dryer Description*).
- Power voltage must be within the values indicated on the rating label (*see Dryer Description*).
- The socket must be compatible with the dryers plug. Should this not be the case, replace the plug or the socket.

! The dryer must not be installed outdoors, even if the space is sheltered. It can be very dangerous if it is exposed to rain or storms.

! Once installed, the dryers electrical wire and plug must be within easy reach.

! Do not use extension cords.

! The power cord must not be bent or squashed.

! The power cord should be regularly checked. If the supply cord is damaged, it must be replaced by the manufacturer, its service agent or similarly qualified persons in order to avoid a hazard. New or longer power cords are supplied at an extra charge by authorised dealers.

! The manufacturer denies any responsibility should any of these rules not be followed.

! If in doubt about any of the above consult a qualified electrician.

## Before you start using your dryer

Once you have installed your dryer and before you use it, clean the inside of the drum to remove any dust that could have accumulated during transport.

## Maximum load

Natural fibres : 8 kg

# Warnings

GB

! The appliance has been designed and built according to international safety standards. These warnings are given for safety reasons and must be followed carefully.

## General safety

- This appliance can be used by children aged from 8 years and above and persons with reduced physical, sensory or mental capabilities, or lack of knowledge if they are given supervision or instruction concerning use of the appliance in a safe way and understand the hazards involved.
- This tumble dryer has been designed for home, and not professional use.
- Do not touch the appliance while bare foot or with wet hands or feet.
- Unplug the machine by pulling on the plug, not the cord.
- After using the dryer, turn it off and unplug it. Keep the door closed to make sure that children do not use it as a toy.
- Children should be supervised to ensure that they do not play with the dryer.
- Cleaning and user maintenance should not be made by children without supervision.
- Children of less than 3 years should be kept away from the appliance unless continuously supervised.
- The appliance must be installed correctly and have proper ventilation. The air intake at the front of the dryer and rear vent behind the dryer should never be obstructed (*see Installation*).
- Never use the dryer on carpeting where the pile height would prevent air from entering the dryer from the base.
- Check to see if the dryer is empty before loading it.
-  The back of the dryer could become very hot. Never touch it while in use.
- Do not use the dryer unless the filter, water container and heat pump filter unit are securely in place (*see Maintenance*).
- Do not overload the dryer (*see Laundry* for maximum loads).
- Do not load items that are dripping wet.
- Carefully check all instructions on clothing labels (*see Laundry*).
- Do not tumble dry large, very bulky items.
- Do not tumble dry acrylic fibres at high temperatures.
- Do not turn off the dryer when there are still warm items inside.
- Clean the filter after each use (*see Maintenance*).
- Empty the water container after each use (*see Maintenance*).
- Clean the heat pump filter unit at regular intervals (*see Maintenance*).
- Do not allow lint to collect around the dryer.
- Never climb on top of the dryer. It could result in damage.
- Always follow electrical standards and requirements (*see Installation*).
- Always buy original spare parts and accessories (*see Service*).

**To minimise the risk of fire in your tumble dryer, the following should be observed:**

- Tumble dry items only if they have been washed with detergent and water, rinsed and been through the spin cycle. It is a fire hazard to dry items that HAVE NOT been washed with water.
- Do not dry garments that have been treated with chemical products.
- Do not tumble dry items that have been spotted or soaked with vegetable or cooking oils, this constitutes a fire hazard. Oil-affected items can ignite spontaneously, especially when exposed to heat sources such as a tumble dryer. The items become warm, causing an oxidation reaction with the oil, Oxidisation creates heat. If the heat cannot escape, items can become hot enough to catch fire. Piling, stacking or storing oil-affected items can prevent heat from escaping and so create a fire hazard. If it is unavoidable that fabrics containing vegetable or cooking oil or those that have been contaminated with hair care products be placed in a tumble dryer they should first be washed with extra detergent - this will reduce, but not eliminate the hazard. They should not be removed from the dryer and piled or stacked while hot.
- Do not tumble dry items that have previously been cleaned in or washed in, soaked in or soiled with petrol/gasoline, dry cleaning solvents or other flammable or explosive substances. Highly flammable substances commonly used in domestic environments including cooking oil, acetone, denatured alcohol, kerosene, spot removers, turpentine, waxes and wax removers. Ensure these items have been washed in hot water with an extra amount of detergent before being dried in the tumble dryer.
- Do not tumble dry items containing foam rubber (also known as latex foam), or similarly textured rubber like materials. Foam rubber materials can, when heated, produce fire by spontaneous combustion.
- Fabric softener or similar products should not be used in a tumble dryer to eliminate the effects of static electricity unless the practice is specifically recommended by the manufacturer of the fabric softener product.
- Do not tumble dry undergarments that contain metal reinforcements eg. bras with metal reinforcing wires. Damage to the tumble dryer can result if the metal reinforcements come loose during drying.
- Do not tumble dry rubber, plastic articles such as shower caps or babies water proof covers, polythene or paper.
- Do not tumble dry rubber backed articles, clothes fitted with foam rubber pads, pillows, galoshes and rubber coated tennis shoes.
- Remove all objects from pockets, such as lighters and matches.

**! WARNING:** Never stop the dryer before the end of the drying cycle unless all items are quickly removed and spread out so that the heat is dissipated.

# Maintenance and Care

GB

## Switching off the electricity

! Unplug your dryer when not using it, when cleaning it and during all maintenance operations.

## Clean the filter after each cycle

The filter is an important part of your dryer: it accumulates lint and fluff that is formed while drying.

When finished drying, clean the filter by rinsing it under running water or with your vacuum cleaner.

Should the filter become clogged up, the airflow inside the dryer will be seriously compromised: drying times lengthen and you will consume more energy. It may also damage your dryer.

The filter is found in front of the dryer trim (see diagram on next page).

Removing the filter:

1. Pull the plastic grip of the filter upwards.
2. Open the filter and clean the lint from the inside.
3. Replace it correctly. Ensure the filter is fully located flush into the tumble dryer trim.

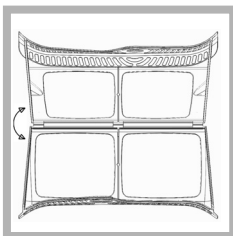

4. Remove any lint that has built up on the inside of the door and around the door seal.

! Do not use the dryer without replacing the filter.

## Cleaning the heat pump filter unit

Periodically (every 5 drying cycles) remove the heat pump filter unit and clean any build up of fluff from the surface of the filter. However, we recommend that you clean this filter after EVERY drying cycle to optimise the dryers performance.

To removing the heat pump filter unit:

1. Unplug the dryer and open the door.
2. Pull open the heat pump filter unit cover (see diagram on next page).

Release the 4 clips to the vertical position then pull the filter unit towards you.

3. Separate the two parts of the filter and clean the surface of the filter.

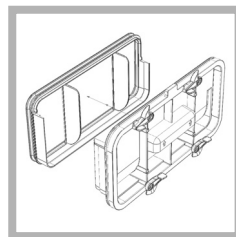

! The front of the heat pump is made from thin metal plates. Take care that you do not damage these or cut yourself when cleaning, removing or replacing the heat pump filter unit.

Whenever you clean the heat pump filter unit always clean any build up of fluff from the surface of the metal plates.

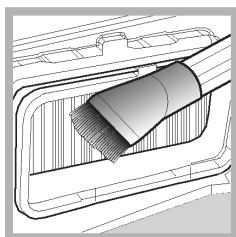

4. Carefully clean this fluff off with a damp cloth, sponge or a vacuum cleaner. Never use your fingers.
5. Reassemble the two parts of the filter, clean the seals and replace with the 4 clips in the horizontal position, make sure that the catches are secure.

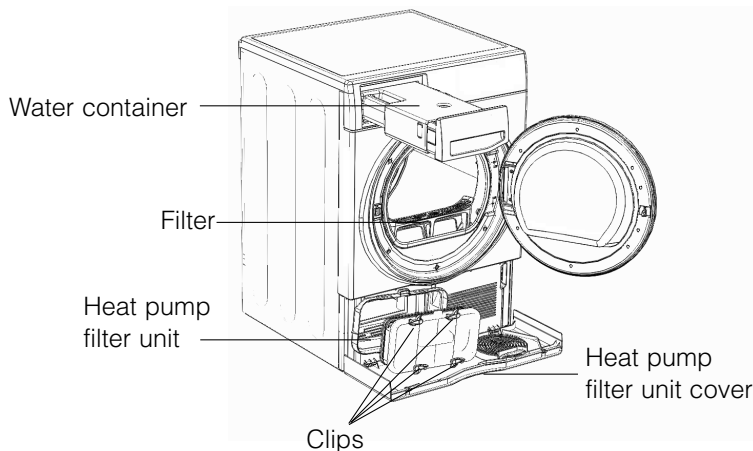

## Empty the water container after each cycle

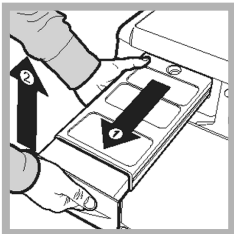

Pull the container out of the dryer and remove either the small or large cap and empty it into a sink or other suitable drain. Refit the cap and replace the container securely.

! Always check and empty the container before you start a new drying programme.

### ! Failure to empty the water container may cause the following:

- The dryer will stop heating (so the load may still be damp at the end of the drying cycle).
- **Priming the water collection system**  
When your dryer is new, the water container will not collect water until the system is primed. This will take 1 or 2 drying cycles. Once primed it will collect water during every drying cycle.

## Check the drum after each cycle

Turn the drum manually in order to remove small items (handkerchiefs) that could have been left behind.

## Cleaning the drum

! Do not use abrasives, steel wool or stainless steel cleaning agents to clean the drum.

A coloured film may start to appear on the stainless steel drum, this may be caused by a combination of water and, or cleaning agents such as fabric conditioner from the wash. This coloured film will not affect the dryer performance.

## Cleaning the dryer

- External parts in metal or plastic and rubber parts can be cleaned with a damp cloth.
- Periodically (every 6 months) vacuum the front air intake grille and vents at the rear of the dryer, to remove any build up of fluff, lint or dust. Also to remove accumulation of fluff from the front of the heat pump and filter areas, clean occasionally with a vacuum cleaner.

! Do not use solvents or abrasives.

! Have your dryer checked regularly by authorised technicians to ensure electrical and mechanical safety (*see Service*).

## Quick Tips

- Remember to clean the door filter and heat pump filter after each load.
- Remember to empty the water container after each load.

! Doing BOTH the above will keep your appliance working at its BEST.

# Dryer Description

GB

## The features

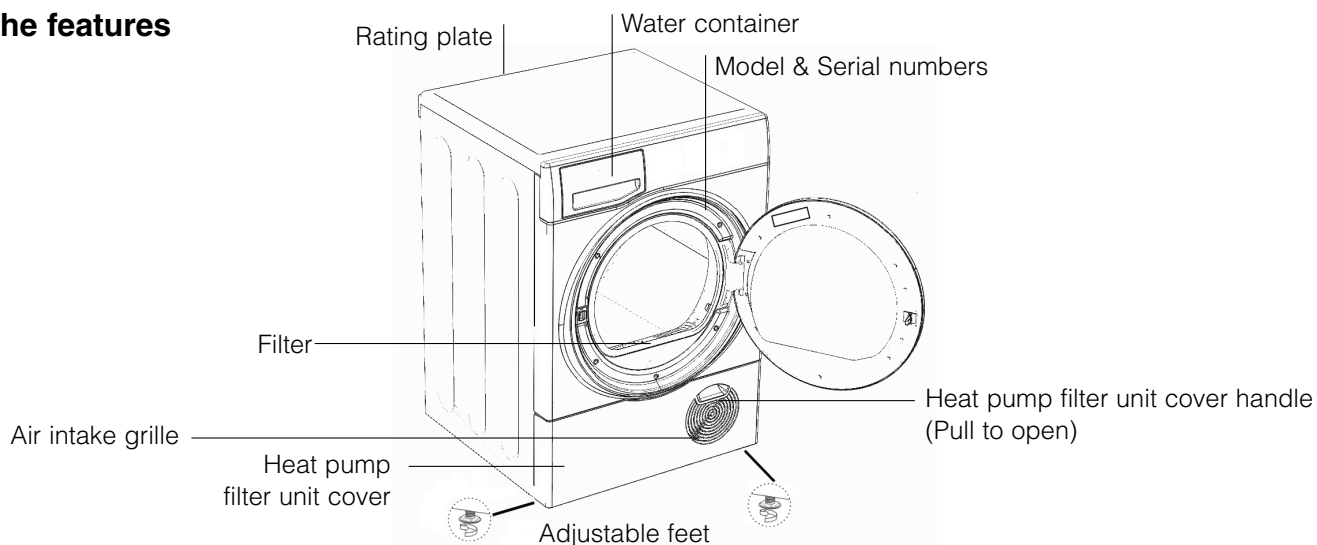

## Control panel

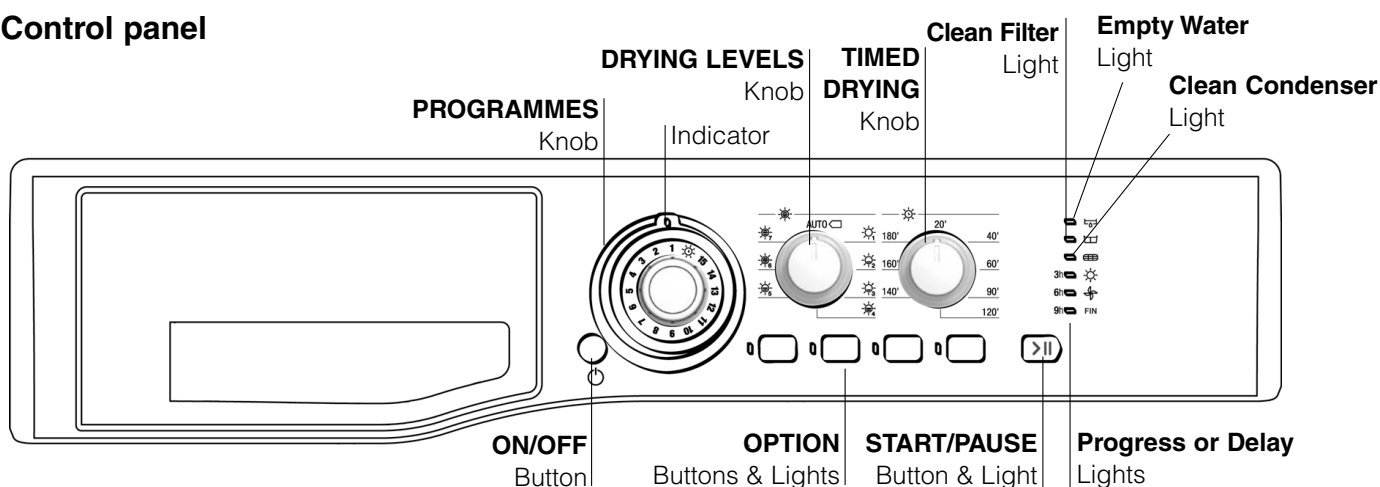

The **ON/OFF** button : If the dryer is running and this button is pressed and held for more than 3 seconds the dryer is turned off, the programme is then cancelled. Press and hold for more than 3 seconds and the dryer reactivates.

The **PROGRAMMES** knob sets the programme: rotate it until the indicator is pointing to the programme you want to select or to Timed Drying (see *Start and Programmes*).

Use the **DRYING LEVELS** knob to set your required dryness sensing level, or the **TIMED DRYING** knob to select a drying time (see *Start and Programmes*).

The **OPTION** buttons/lights select available options for your selected programme. The lights indicate that the option has been selected (see *Start and Programmes*).

The **START/PAUSE** button/light  starts a selected programme. When you press this button there will be one beep and the progress lights will flash to confirm the action. When a programme is running, pressing this button in pauses the programme and stops the dryer. The light is green when programme is running, flashing amber if the programme has been paused or flashing green if on standby waiting to start a programme (see *Start and Programmes*).

**Note:** This light also flashes amber during the Post Care phase of a programme.

The **Progress or Delay** lights show you the status of the programme, or the delay time when they flash. During a delayed start the lights flash to show the delay selected. When (not flashing) they show each stage of the programme by the corresponding light turning on (see *Start and Programmes*).

The **Empty Water** indicator light signals that the water container should be emptied. The light will take a few seconds to go out after replacing the empty water container, the dryer must be running for this to happen (see *The Controls*).

**Note:** If the water bottle fills the indicator light flashes, the heat is turned off and your clothes will not dry.

The **Clean Filter** light gives you a reminder before every programme that it is essential to clean the filter every time the dryer is used (see *Maintenance and Care*).

The **Clean Condenser** light gives you a reminder that it is essential to clean the condenser at regular intervals (see *Maintenance and Care*).



## Dryness Sensing Levels

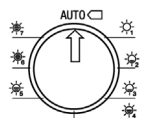

After selecting a programme that has a Sensor Dry option, turn the selection knob to the required dryness sensing level. If the sensing option is not available with your selected programme, the buzzer will beep three times.

! Some sensing programmes do not have all seven dryness level options available.

Dryness levels:

- Damp Dry:** Dries your items ready to be ironed using a machine or rotary ironer.
- Iron Dry:** Dries your items ready to be ironed with a hand iron.
- Hanger Dry Plus:** Dries your delicate items ready to be hanged for final drying.
- Hanger Dry:** Dries your items ready to be hanged for final drying.
- Light Dry:** Dries your delicate items ready to be put away.
- Cupboard Dry:** Dries your items ready to be put away.
- Extra Dry:** Dries your items ready to be worn.
- AUTO:** Turn the selection knob to this position and the default sensing level will be selected. Use this setting for the Standard Cotton programme to EU Regulation 392/2012 (for Default *see Programmes Tables*).

## Timed Dry

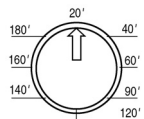

First turn the PROGRAMMES knob to the Timed Dry position and turn the Timed Dry knob to your required drying time (*see Laundry*).

## Choosing a programme

1. Plug the dryer into the electrical socket.
2. Sort your laundry according to fabric type (*see Laundry*).
3. Open the door and make sure the filter is clean and in place and the water container is empty and in place (*see Maintenance*).
4. Load the machine and make sure items are not in the way of the door seal. Close the door.
5. If none of the lights are on: Press the ON/OFF button .
6. Choose a programme, or Timed Drying, by checking the Programmes Guide (*see Programmes*) as well as the indications for each type of fabric (*see Laundry*).
  - Select a programme by rotating the PROGRAMMES knob.
7. Choose Timed Drying or Dryness Levels option.
  - ! For full details of selections available for each programme *see the Programme Tables*.
8. Set a delay time and other options if necessary.
9. The START/PAUSE light is flashing green:
  - press the START/PAUSE to begin. The green light stops flashing.
  - During the drying programme, you can check on your laundry and take out items that are dry while others continue drying. When you close the door again, press the START/PAUSE button in order to resume drying.
10. At the end of the drying cycle the End light comes on and either :
  - The buzzer will beep 3 times to let you know that your programme is complete.
  - or - If you have selected the Crease Care option and you do not take the items out immediately, the items will tumble occasionally for 10 hours or until you open the door, the buzzer will then beep 3 times to confirm the programme is completed.
11. Open the door, take the laundry out, clean the filter and replace it. Empty the water container and replace it (*see Maintenance*).
12. Unplug the dryer.

If you open the door to check your laundry you will extend the drying time as the heat pump compressor will not start for 5 minutes after you close the door and press the Start/Pause button (*see The Controls*).

*(When the door is opened the START/PAUSE light will flash Amber, after the door is closed and the START/PAUSE button pressed, the START/PAUSE light will stop flashing and show green.)*

**Note:** *During the Post Care phase this light flashes Amber.*

**Note:** This tumble dryer, in compliance with new energy saving regulations, is fitted with an automatic standby system which is enabled after about 30 minutes if no activity is detected. Press and hold the ON/OFF button until the dryer reactivates.

# Start and Programmes

GB

## ESSENTIAL PROGRAMMES - Programmes Table

Programme	Options available					Dryness Levels available (default AUTO highlighted <input checked="" type="checkbox"/> )						
	Delay Timer	Extra Care*	Crease Care	High Heat	Sensor Dry	Damp Dry	Iron Dry	Hanger Dry Plus	Hanger Dry	Light Dry	Cupboard Dry	Extra Dry
Timed Drying	<input checked="" type="checkbox"/>	<input checked="" type="checkbox"/>	<input checked="" type="checkbox"/>	<input checked="" type="checkbox"/>	<input checked="" type="checkbox"/>	<input checked="" type="checkbox"/>	<input checked="" type="checkbox"/>	<input checked="" type="checkbox"/>	<input checked="" type="checkbox"/>	<input checked="" type="checkbox"/>	<input checked="" type="checkbox"/>	<input checked="" type="checkbox"/>
1 Standard Cotton	<input checked="" type="checkbox"/>	<input checked="" type="checkbox"/>	<input checked="" type="checkbox"/>	High	<input checked="" type="checkbox"/>	<input checked="" type="checkbox"/>	<input checked="" type="checkbox"/>	<input checked="" type="checkbox"/>	<input checked="" type="checkbox"/>	<input checked="" type="checkbox"/>	<input checked="" type="checkbox"/>	<input checked="" type="checkbox"/>
				Low	<input checked="" type="checkbox"/>	<input checked="" type="checkbox"/>	<input checked="" type="checkbox"/>	<input checked="" type="checkbox"/>	<input checked="" type="checkbox"/>	<input checked="" type="checkbox"/>	<input checked="" type="checkbox"/>	<input checked="" type="checkbox"/>
2 Shirts	<input checked="" type="checkbox"/>	<input checked="" type="checkbox"/>	<input checked="" type="checkbox"/>	<input checked="" type="checkbox"/>	<input checked="" type="checkbox"/>	<input checked="" type="checkbox"/>	<input checked="" type="checkbox"/>	<input checked="" type="checkbox"/>	<input checked="" type="checkbox"/>	<input checked="" type="checkbox"/>	<input checked="" type="checkbox"/>	<input checked="" type="checkbox"/>
3 Bed & Bath	<input checked="" type="checkbox"/>	<input checked="" type="checkbox"/>	<input checked="" type="checkbox"/>	<input checked="" type="checkbox"/>	<input checked="" type="checkbox"/>	<input checked="" type="checkbox"/>	<input checked="" type="checkbox"/>	<input checked="" type="checkbox"/>	<input checked="" type="checkbox"/>	<input checked="" type="checkbox"/>	<input checked="" type="checkbox"/>	<input checked="" type="checkbox"/>
4 Synthetics	<input checked="" type="checkbox"/>	<input checked="" type="checkbox"/>	<input checked="" type="checkbox"/>	<input checked="" type="checkbox"/>	<input checked="" type="checkbox"/>	<input checked="" type="checkbox"/>	<input checked="" type="checkbox"/>	<input checked="" type="checkbox"/>	<input checked="" type="checkbox"/>	<input checked="" type="checkbox"/>	<input checked="" type="checkbox"/>	<input checked="" type="checkbox"/>
5 Anti Allergy	<input checked="" type="checkbox"/>	<input checked="" type="checkbox"/>	<input checked="" type="checkbox"/>	<input checked="" type="checkbox"/>	• An Automatic programme							
6 Quick Dry	<input checked="" type="checkbox"/>	<input checked="" type="checkbox"/>	<input checked="" type="checkbox"/>	<input checked="" type="checkbox"/>	• An Automatic programme							

**Note:** \*Extra Care not available with dryness levels: Extra Dry , Cupboard Dry or Light Dry

### Standard Cotton

- This is a programme for cotton items.
- The duration of this programme will depend on the size of the load, the dryness setting selected and the spin speed used in your washer (see *Laundry*).
- The Standard Cotton programme to EU Regulation 392/2012 is Programme 1 selection with Dryness Level AUTO or Cupboard Dry (the standard/default starting configuration). It is the most efficient programme in terms of energy consumption (to EU.392/2012).

### Shirts

#### High heat option

- This is a programme for shirts made from cotton.
- It can be used for load sizes up to 3kg (approximately 10 shirts).
- This programme will take about 80 minutes, but may take longer depending on the size of the load and the spin speed used in your washer.

#### Low heat option

- This is a programme for shirts made from synthetic materials or a mixture of natural and synthetic materials, such as polyester and cotton.
- It can be used for load sizes up to 3kg (approximately 14 shirts).
- This programme will take about 65 minutes, but may take longer depending on the size of the load and the spin speed used in your washer.

Loads dried using the Cupboard Dry setting are usually ready to wear, the edges or seams may be slightly damp. If this is the case, try turning the shirts inside out and running the programme again for a short period.

### Bed & Bath

- This is a programme for cotton towels and sheets.
- This programme will take about 170 minutes, but may take longer depending on the size of the load and the spin speed used in your washer (see *Laundry*).
- Loads dried using the Extra Dry setting are usually ready to use, the edges or seams may be slightly damp especially on large items. If this is the case, try opening them out and running the programme again for a short period.

### Synthetics

- This is a programme for items of Synthetic or Synthetic/Cotton mixtures.
- The duration of this programme will depend on the size of the load, the dryness setting selected and the spin speed used in your washer (see *Laundry*).

### Anti Allergy Programme

This programme has the 'Seal of Approval' endorsement from Allergy UK, which reflects the effective reduction and elimination of allergens from the clothes with the special Anti Allergy cycle. With this programme, thanks to the achievement of constant temperature for an extended period of time, the effects of the most common allergens (including House Mites and Pollen) are neutralised.

Can be used on a full size wet load to dry and treat, or on a 4kg dry load just to treat your laundry. This programme will take about 200 minutes but may take longer depending on the size of the load, and the spin speed used in your washer if used on a wet load.

### Quick Dry

This programme is for small loads maximum 1kg. **Note:** can only be used with the Cupboard Dry setting. Your drying time is very much reduced with a huge time saving up to 53% on cottons (with High Heat option) and 50% on synthetics (with Low Heat option). This programme will take about 30 minutes.

# Start and Programmes

## ☆ EXCLUSIVE PROGRAMMES - Programmes Table

Programme	Options available					Dryness Levels available (default AUTO highlighted <input checked="" type="checkbox"/> )						
	Delay Timer	Extra Care	Crease Care	High Heat	Sensor Dry	Damp Dry	Iron Dry	Hanger Dry Plus	Hanger Dry	Light Dry	Cupboard Dry	Extra Dry
<b>7</b> Jeans	✓	✗	✓	✗	✓	✓	✓	✓	✓	✓	<input checked="" type="checkbox"/>	✓
<b>8</b> Delicates	✓	✗	✓	✗	✓	✓	✓	✓	✓	✓	<input checked="" type="checkbox"/>	✗
<b>9</b> Baby cycle	✓	✗	✓	✗	✓	✓	✓	✓	✓	✓	<input checked="" type="checkbox"/>	✗
<b>10</b> Wool	✗	✗	✗	✗	• An Automatic programme							
<b>11</b> Silk	✗	✗	✗	✗	• An Automatic programme							
<b>12</b> Cuddly Toys	✓	✗	✗	✗	• An Automatic programme							

### Jeans

- This is a programme for jeans made from denim cotton. Before drying your jeans turn the front pockets inside out.
  - It can be used for load sizes up to 3kg (approximately 4 pairs).
  - Do not mix dark and light coloured items.
  - It can also be used on other garments made from the same material, such as jackets.
  - This programme will take about 75 minutes, but may take longer depending on the size of the load and the spin speed used in your washer.
  - Loads dried using this programme are usually ready to wear, the edges or seams may be slightly damp. If this is the case, try turning the jeans inside out and running the programme again for a short period.
- ! We do not recommend that you use this programme if your jeans have elastic waist bands, studs or embroidery.

### Delicates

- This is a programme for drying your delicate clothes ie. Acrylics.
- It can be used for load sizes up to 2kg.
- This programme will take about 120 minutes, but may take longer depending on the size and density of the load and the spin speed used in your washer.
- Loads dried using this programme are usually ready to use, but on some garments the edges may be slightly damp. If this is the case, try opening them out or turn items inside out and running the programme again for a short period.

### Baby Programme

- This is a programme for drying your baby's small delicate items of clothing and bedding (Cotton and Chenille) and for drying your delicate clothes.
- DO NOT dry items such as bibs and nappy pants with plastic coverings.
- It can be used for load sizes up to 2kg.
- This programme will take about 85 minutes, but may take longer depending on the size and density of the load and the spin speed used in your washer.
- Loads dried using this programme are usually ready to wear, but on some heavier garments the edges may be slightly damp. If this is the case, try turning items inside out and running the programme again for a short period.

### Wool Programme

- This is a programme for tumble dryer safe garments marked with the symbol .
  - It can be used for load sizes up to 1kg (approximately 3 sweaters).
  - We recommend that garments are turned inside out before drying.
  - This programme will take about 60 minutes, but may take longer depending on the size and density of the load and the spin speed used in your washer.
  - Loads dried using this programme are usually ready to wear, but on some heavier garments the edges may be slightly damp. Allow these to dry naturally as over-drying could damage garments.
- ! Unlike other materials, the mechanism of wool shrinkage is irreversible; i.e. it will not stretch back to original size and shape.
- ! This programme is not suitable for Acrylic garments.

# Start and Programmes

GB

## Silk

- This is a programme for drying your delicate silk.
- It can be used for load sizes up to 0.5kg.
- This programme will take about 50 minutes, but may take longer depending on the size and density of the load and the spin speed used in your washer.
- Loads dried using this programme are usually ready to use, but on some heavier garments the edges may be slightly damp. If this is the case, remove the load and open them out and then run the programme again for a short period.

## Cuddly Toy Programme









With this programme you can remove dust easier and wash the cuddly toys more often because the drying time is very much reduced compared to drying in the open air. It is a delicate drying cycle that dries at low temperature and with soft mechanical action to maintain at best the original look and shine of the fur.

**Note:** For allergy protection, just freeze cuddly toys for 24 hours then wash and dry them. Repeat every 6 weeks. Before drying remove accessories such as clothes, collars or sound boxes and protect plastic eyes with masking tape after drying them with a cloth.

The maximum load should not exceed 2.5kg and no individual item should be greater than 600g.

This programme will take about 230 minutes, but may take longer depending on the size and density of the load and the spin speed used in your washer.

## EXTRA PROGRAMMES - Programmes Table

Programme	Options available					Dryness Levels available (default highlighted <input checked="" type="checkbox"/> )						
	Delay Timer	Extra Care	Crease Care	High Heat	Sensor Dry	Damp Dry	Iron Dry	Hanger Dry Plus	Hanger Dry	Light Dry	Cupboard Dry	Extra Dry
<b>13 Heat &amp; Enjoy</b>	X	X	X	X								
<b>14 Easy Iron</b>	X	X	X	X								
<b>15 Refresh</b>	X	X	X	X								

## Heat & Enjoy

This programme helps to heat towels & bathrobes for a warm sensation after a bath or shower. It is also useful for warming clothes before dressing during winter. The cycle heats clothes to 37°C (Body Temperature) and runs at this temperature for a maximum of 4 hours or until you stop the cycle by opening the door.

Maximum load 3kg.

## Easy Iron Programme

'Easy Iron' is a short 10 minute programme (8 minutes of heat followed by a 2 minute cool tumble period) which fluffs the fibres of clothing that have been left in the same position/location for an extended period of time. The cycle relaxes the fibres and makes them easier to iron and fold.

! 'Easy Iron' is **not a drying programme** and should not be used for wet articles of clothing.

For best results: 1. Do not load more than the maximum capacity. These numbers refer to the dry weight:

Fabric	Maximum load
Cotton and Cotton mixtures	2.5kg
Synthetics	2kg
Denim	2kg

2. Unload the dryer immediately after the end of the programme, hang, fold or iron the articles and put them away in the closet. Should this not be possible repeat the programme.

The 'Easy Iron' effect varies from one fabric to the next. It works well on traditional fabrics like Cotton or Cotton mix, and less well on acrylic fibres and on materials such as Tencel®.

## Refresh

! 'Refresh' is **not a drying programme** and should not be used for wet articles of clothing.

- It can be used on any load size but is more effective on smaller loads.
- Do not overload your dryer (*see Laundry*).
- This is a 20 minute programme that airs your clothes with cool air. Also use to cool warm clothes.

## The Controls

### • PROGRAMMES knob

**! Warning**, if after pressing the start button, the programmes knob position is changed, the new position will **NOT** change the programme selected.

To change a selected programme, press the Start/Pause button >||, the light flashes Amber to indicate the programme is paused. Select the new programme and any options required, the light will then flash green. Press the Start/Pause button >|| again and the new programme will start.

### • OPTION buttons / lights

These buttons are used to customise the selected programme to your requirements. Not all options are available for all programmes (*see Start and Programmes*). If an option is not available and you press the button, the buzzer will beep three times. If the option is available the option light next to the button lights to confirm the selection.

### Progress (☀️ Drying, 🌀 Cool Tumble, END) / Delay (3hr 6hr 9hr) Lights

When the light next to the delay button is on, these lights flash to indicate the delay time selected. During other programmes they indicate the progress of the dryer, each one comes on as the corresponding phase starts.

#### Delay Timer (Delay)

The start of some programmes (*see Start and Programmes*) can be delayed for up to 9 hours in 3hr steps. Ensure the water bottle is emptied before setting a delayed start.

When a delayed start is in progress the light next to the delay button will be on and the selected delay period light will flash (after the start button has been pressed). To set a delayed start, press the Delay Timer button, and the light next to the button will come on together with the 3hr delay light. Pressing the button again will advance the delay setting to 6hr, the 3hr light goes out and the 6hr light is on. Each time you press the button the delay setting advances 3 hours, as indicated by the corresponding light. If the 9hr light is on, pressing the button again will cancel the delay. Holding in the On/Off button will also cancel.

#### Extra Care

This Anti-Ageing function for Cottons helps to maintain the brightness of your laundry for a long time, thanks to the correct drum rotation (reduced in the last part of the cycle) and the correct temperature.

**Note:** It cannot be used with the 'Extra Dry', 'Cupboard Dry' and 'Light Dry' dryness levels.

#### Crease Care

The *pre-care option* is only available if a delayed start has been selected. It tumbles the clothes occasionally during the delayed period to help prevent creases developing.

The *post-care option* occasionally tumbles the clothes after the end of the drying and cool tumble cycles to prevent creases developing, should you not be available to remove the load immediately the programme is complete. The End light is on during this phase.

**Note:** The Start/Pause light flashes Amber during this phase.

Selecting this option enables both the pre and post care functions if appropriate.

### High Heat

Press this button and a high heat setting is selected and the light next to the button comes on. If the light alongside the button is on then pressing the button selects a low heat setting and the light goes out. Not all programmes allow you to change this setting.

### Empty Water Light / Container

(If you have plumbed your dryer to a drain this light can be ignored, as there is no need to empty the water container).

When this light is on (not flashing) it reminds you to empty the water container.

If the water container fills during a programme, the heater turns off and the dryer does a period of Cool Tumble then the light flashes and the buzzer sounds. You must empty the water container and restart the dryer or the clothes will not dry. After re-starting the dryer, the light will take a few seconds to go out.

To avoid this always empty the water container each time you use the dryer (*see Maintenance*).

### • Door Opening

Opening the door (or pressing the Start/Pause button) during a programme will stop the dryer and have the following effects:

**Note:** The Start/Pause light flashes Amber during the Post Care phase of a programme.

- The Start/Pause light flashes Amber.
- During a delay phase the delay will continue to count down. The Start/Pause button **must** be pressed to resume the delay programme. One of the delay lights will flash to show the current delay setting.
- The Start/Pause button **must** be pressed to resume the programme. The progress lights will change to show the current status and the Start/Pause light will stop flashing and turn green.
- During the Post Creasecare phase of a drying programme, the programme will finish. Pressing the Start/Pause button will re-start a new programme at the beginning.
- Changing the programmes knob will select a new programme and the Start/Pause light will flash green. You can use this to select the Refresh programme to cool the clothes, if you find them dry enough. Press the Start/Pause button to begin a new programme.

### • Heat Pump Protection System

The heat pump system has a compressor protection feature that operates if you open the door or there is a power disruption or if you turn off the dryer. This system will prevent the heat pump compressor from starting for 5 minutes after the door is closed and the programme is started.

### • Note

If you have a power cut, switch off the power or remove the plug. When power is restored, press and hold the ON/OFF button until the dryer reactivates, then press the Start/Pause button.

# Laundry

GB

## Sorting your laundry

- Check symbols on clothing labels to make sure that the articles can be tumble dried.
  - Sort laundry by fabric type.
  - Empty pockets and check buttons.
  - Close zippers and hooks and tie loose belts and strings.
  - Wring out each item in order to eliminate as much excess water as possible.
- ! Do not load dripping wet clothes into the dryer.





## Maximum load size

Do not load more than maximum capacity.  
 These numbers refer to dry weight:  
 Natural fibres: 8kg max (18lb)  
 Synthetic fibres: 3kg max (6.6lb)

! DO NOT overload the dryer as this could result in reduced drying performance.

## Wash Care Labels

Look at the labels on your garments, especially when tumble drying for the first time. The following symbols are the most common:

-  May be tumble dried
-  Do **not** tumble dry
-  Tumble dry at high heat setting
-  Tumble dry at low heat setting

## Drying times

The table (*see below*) presents APPROXIMATE drying times in Minutes. Weights refer to dry garments.

Times are approximate and can vary depending upon:

- Amount of water retained in clothes after spin cycle: towels and delicates retain a lot of water.
- Fabrics: items that are the same type of fabric but different textures and thicknesses may not have the same drying time.
- Quantity of laundry: single items or small loads may take longer to dry.
- Dryness: If you are going to iron some of your clothes, they can be taken out while still a bit damp. Others can be left longer if you need them to be completely dry.
- Heat setting.
- Room temperature: if the room where the dryer is located is cold, it will take longer for the dryer to dry your clothes.
- Bulk: some bulky items can be tumble dried with care. We suggest that you remove these items several times, shake them out, and return them to the dryer until finished.

! Do not over-dry your clothes.  
 All fabrics contain a little natural moisture, which keeps them soft and fluffy.

<b>Cottons</b>		High Heat			- spin speed 800-1000 rpm in washing machine.			
Load size	1 kg	2 kg	3 kg	4 kg	5 kg	6 kg	7 kg	8 kg
Drying times, in minutes	60 - 90	80 - 100	120 - 130	120 - 140	140 - 180	150 - 190	170 - 200	200 - 240
<b>Synthetics</b>		Low Heat			- on reduced spin in washing machine.			
Load size	1 kg		2 kg		3 kg			
Drying times, in minutes	40 - 50		50 - 60		60 - 90			
<b>Delicates e.g. Acrylics</b>		Low Heat			- on reduced spin in washing machine.			
Load size	1 kg			2 kg				
Drying times, in minutes	40 - 80			80 - 140				

- **Note:** At the end of a drying cycle, cottons could still be damp if you grouped cottons and synthetics together. If this is the case, simply give the damp cotton items an additional short period of drying.

One day your dryer seems not to be working. Before you call your Service Centre (*see Service*), go through the following troubleshooting suggestions:

<b>Problem:</b>	<b>Possible causes / Solution:</b>
<b>The tumble dryer won't start.</b>	<ul style="list-style-type: none"><li>• The plug is not plugged into the socket, or not making contact.</li><li>• There has been a power failure.</li><li>• The fuse has blown. Try to plug another appliance into the socket.</li><li>• You are using an extension cord? Try to plug the dryer's power cord directly into the socket.</li><li>• The door is not closed securely?</li><li>• The PROGRAMMES knob has not been set properly (<i>see Start and Programmes</i>).</li><li>• The START/PAUSE button has not been pressed (<i>see Start and Programmes</i>).</li></ul>
<b>Drying cycle will not begin.</b>	<ul style="list-style-type: none"><li>• You have set a delayed time (<i>see Start and Programmes</i>).</li></ul>
<b>Its taking a long time to dry.</b>	<ul style="list-style-type: none"><li>• The filter has not been cleaned (<i>see Maintenance</i>).</li><li>• The water container needs emptying? The empty water light is flashing? (<i>see Maintenance</i>).</li><li>• The heat pump filter needs cleaning? (<i>see Maintenance</i>).</li><li>• The temperature setting is not ideal for the type of fabric you are drying (<i>see Start and Programmes, and see Laundry</i>).</li><li>• The correct drying time has not been selected for the load (<i>see Laundry</i>).</li><li>• The air intake grille is obstructed (<i>see Installation, and see Maintenance</i>).</li><li>• The items were too wet (<i>see Laundry</i>).</li><li>• The dryer was overloaded (<i>see Laundry</i>).</li></ul>
<b>Empty water light is flashing but the dryer has only been running for a short period.</b>	<ul style="list-style-type: none"><li>• The water container was probably not emptied at the start of the programme. Do not wait for the empty water signal, always check and empty the container before starting a new drying programme (<i>see Maintenance</i>).</li></ul>
<b>Empty water light is on and the water container is not full.</b>	<ul style="list-style-type: none"><li>• This is normal, the light flashes when the container is full. If the light is on but not flashing it is just a reminder to empty the container (<i>see Start and Programmes</i>).</li></ul>
<b>The OPTION lights and the START/PAUSE light Flash amber.</b>	<ul style="list-style-type: none"><li>• If the Option lights and the START/PAUSE light flash together with other lights on, then:<ul style="list-style-type: none"><li>- Turn off and remove the plug. Clean the filter and the heat pump filter (<i>see Maintenance</i>). Then replace the plug, turn on and start another programme. If the same combination of lights are on, note down the lights and contact the Service Centre (<i>see Service</i>).</li></ul></li></ul>
<b>Programme finishes and clothes are damper than expected.</b>	<p>! For safety the dryer has a maximum programme time of 5 hours. If an automatic programme has not sensed the required final moisture in this time the dryer will complete the programme and stop. Check the above points and run the programme again, if the results are still damp, contact the Service Centre (<i>see Service</i>).</p>
<b>The lights on the dryer control panel are off although the dryer is switched on.</b>	<ul style="list-style-type: none"><li>• The dryer has gone into standby mode to save power. This occurs :<ul style="list-style-type: none"><li>- if you have left the dryer on or have had a power cut</li><li>- if you leave the dryer without starting a programme</li><li>- after your drying programme has finished</li></ul>Press and hold the On/Off button and the lights will come on again.</li></ul>

# Assistance and Guarantee

GB

## Heat Pump System

This dryer is fitted with a sealed heat pump system to dry your clothes. To operate, the heat pump contains fluorinated greenhouse gases (F gases) which are covered by the Kyoto Protocol. These F gases are contained in a hermetically sealed unit. This sealed unit contains 0.29kg of the F gas R134a which acts as a refrigerant. If the sealed unit fails then it must be replaced by a new sealed unit. Contact your nearest Service Centre for advice.

- **Note:** The gases contained in the sealed system are not hazardous to health, but if they escape they will have an impact on global warming.

## Spare Parts

This dryer is a complex machine. Repairing it yourself or having a non-authorized person try to repair it could cause harm to one or more persons, could damage the machine and could invalidate the spare parts warranty. Call an authorised technician if you experience problems while using the machine.

- **Please note:** it is an offence for an unqualified person to undertake any servicing or repair work that involves breaking into the sealed heat pump unit.

# Product Guarantee and Repair Information

## Guarantee - 12 Months Parts and Labour Guarantee

Your appliance has the benefit of our manufacturer's guarantee, which covers the cost of breakdown repairs for twelve months from the date of purchase.

This gives you the reassurance that if, within that time, your appliance is proven to be defective because of either workmanship or materials, we will, at our discretion, either repair or replace the appliance at no cost to you.

***This guarantee is subject to the following conditions :***

- the appliance has been installed and operated correctly and in accordance with our operating and maintenance instructions.
- the appliance is used only on the electricity or gas supply printed on the rating plate.
- the appliance has been used for normal domestic purposes only.
- the appliance has not been altered, serviced, maintained, dismantled or otherwise interfered with by any person not authorised by us
- any repair work must be undertaken by us or our appointed agent.
- any parts removed during repair work or any appliance that is replaced become our property.
- the appliance is used in the United Kingdom or Republic of Ireland.

***This guarantee does not cover :***

- damage resulting from transportation, improper use, neglect or interference or as a result of improper installation.
- replacement of any consumable item or accessory. These include but are not limited to: plugs, cables, batteries, light bulbs, fluorescent tubes and starters, covers and filters.
- replacement of any removable parts made of glass or plastic.

THIS GUARANTEE WILL NOT APPLY IF THE APPLIANCE HAS BEEN USED IN COMMERCIAL OR NON-DOMESTIC PREMISES.

***Repairs and After Sales :*** For product help and advice, repairs, spare parts or accessories, we are here to help.

For local repair engineers :

- in the United Kingdom: 03448 111 606 standard local rate applies
- in the Republic of Ireland: 0818 313 413 local Irish rate applies

For parts and accessories visit : [parts.hotpoint.co.uk/shop](http://parts.hotpoint.co.uk/shop)

Please remember to register your appliance at : [www.hotpointservice.co.uk](http://www.hotpointservice.co.uk) to activate your 10 year parts guarantee.

Please note our advisors will require the following information :

- model number and serial number (this information can be found on the rating plate, located behind the door.

***Before calling the Service Centre :***

- Follow the 'Troubleshooting' guide to check whether problems can be solved personally (*see Troubleshooting*).

---

# Save energy and respect the environment

- Wring out items to eliminate excess water before tumble drying (if you use a washing machine first, select a high spin cycle). Doing this will save time and energy during drying.
- Always dry full loads - you save energy: single items or small loads take longer to dry.
- Clean the filter after each use to contain energy consumption costs (*see Maintenance*).



Brand <b>Hotpoint</b>	Models <b>FTCL87</b>
Rated capacity of Cotton laundry for the standard programme at full load <b>8 kg</b>	Energy efficiency class <b>A+</b>
The weighted Annual Energy Consumption ( $AE_c$ ) <b>305.4 kWh</b> Consumption per year, based on 160 drying cycles of the standard cotton programme at full and partial load, and the consumption of the low-power modes. Actual energy consumption per cycle will depend on how the appliance is used.	
This household tumble dryer is an <b>Automatic Condenser Dryer</b>	
Energy consumption : full load $E_{dry}$ <b>2.59 kWh</b> , partial load $E_{dry1/2}$ <b>1.39 kWh</b>	
Power consumption : off-mode ( $P_o$ ) <b>0.14 W</b> , left-on mode ( $P_l$ ) <b>2.12 W</b>	
Duration of the 'left-on mode' for power management systems <b>30</b> minutes	
The 'standard cotton programme' suitable for drying normal wet cotton laundry that is the most efficient programme in terms of energy consumption for cotton used at full and partial load is <b>Standard Cotton, High Heat, Cupboard Dry</b>	
Programme time (minutes) : weighted ( $T_l$ ) full & partial load <b>178</b> , full load ( $T_{dry}$ ) <b>237</b> , partial load ( $T_{dry1/2}$ ) <b>133</b>	
Condensation efficiency class <b>B</b>	
Average condensation efficiency (%) : full load ( $C_{dry}$ ) <b>82</b> , partial load ( $C_{dry1/2}$ ) <b>80</b> , weighted ( $C_l$ ) full & partial load <b>81</b>	
Airborne acoustical noise emissions <b>70 dB(A) re 1 pW</b>	

\* "consumer information in compliance with EU Regulation 932/2012".

Typical energy used	- Synthetics	full load <b>0.68 kWh</b> ,	partial load <b>not applicable</b>
Typical drying time	- Synthetics	full load <b>70</b> minutes,	partial load <b>not applicable</b>

## Recycling and Disposal Information



As part of our continued commitment to helping the environment, we reserve the right to use quality recycled components to keep down customer costs and minimise material wastage.

- Disposing of the packaging material: follow local regulations, so the packaging can be recycled.
- To minimise risk of injury to children, remove the door and plug - then cut off mains cable, flush with the appliance. Dispose of these parts separately to ensure that the appliance can no longer be plugged into a mains socket.

### Disposal of old electrical appliances

The European Directive 2012/19/EC on Waste Electrical and Electronic Equipment (WEEE), requires that old household electrical appliances must not be disposed of in the normal unsorted municipal waste stream. Old appliances must be collected separately in order to optimise the recovery and recycling of the materials they contain and reduce the impact on human health and the environment.

This dryer has a sealed heat pump unit containing F gases which should be recovered and destroyed.



The crossed out "wheeled bin" symbol on the product reminds you of your obligation, that when you dispose of the appliance it must be separately collected.

Consumers should contact their local authority or retailer for information concerning the correct disposal of their old appliance.



This appliance conforms to the following EC Directives:  
 - 2006/95/EC (Low Voltage Equipment)  
 - 2004/108/EC (Electromagnetic Compatibility)







195133929.00 N

04/2015 - LION fpg . Four Ashes, Wolverhampton

GB